



**Instruction Manual
Models 610B, 610BR
Multi-Range Electrometers**

Keithley Instruments, Inc.
28775 Aurora Road/Cleveland, Ohio 44139/(216) 248-0400

TABLE OF CONTENTS

Section	Page	Section	Page
1. GENERAL DESCRIPTION	1	4-6. Calibration Procedures	32
1-1. General	1	4-7. Grid Current Check	33
1-2. Features	1	4-8. DC Amplifier Adjustment	33
1-3. Differences Between the Models 610B and 610BR	1	4-9. High-Megohm Resistor Veri- fication	34
1-4. Specifications	2	4-10. Calibration of Ohms Ranges	35
1-5. Applications	3	4-11. Meter Zero Calibration	35
1-6. Accessories	4	4-12. Accuracy Check	35
1-7. Equipment Shipped	4	4-13. Drift Check	36
2. OPERATION	5	5. ACCESSORIES	43
2-1. Front Panel Controls and Terminals	5	5-1. Model 6101A Shielded Test Lead	43
2-2. Rear Panel Controls and Terminals	6	5-2. Model 6101B Gripping Probe	43
2-3. Input Connections	6	5-3. Model 6102A Voltage Divider Probe	43
2-4. Preliminary Procedures	8	5-4. Model 6103A Voltage Divider Probe	43
2-5. Voltage Measurements	9	5-5. Model 6104 Test Shield	44
2-6. Current Measurements	10	5-6. Model 6105 Resistivity Adapter	44
2-7. Resistance Measurements	13	5-7. Models 2501 and 2503 Static Detector Heads	45
2-8. Charge Measurements	15	5-8. Model 6106 Electrometer Connection Kit	46
2-9. Recorder Outputs	15	5-9. Model 6107 pH Electrode Adapter	47
2-10. Unity-Gain Output	17	5-10. Model 370 Recorder	48
2-11. Current Source	17	6. REPLACEABLE PARTS	51
2-12. Static Charge Measurements	17	6-1. Replaceable Parts List	51
2-13. Capacitance Measurements	18	6-2. How to Order Parts	51
2-14. Application Notes	19	Models 610B, 610BR Replaceable Parts List	52
3. CIRCUIT DESCRIPTION	21	Model 610B Schematic Diagram 17795E	59
3-1. General	21	Green Repair and Calibration Forms	61
3-2. Voltmeter Operation	21	* Change Notice	Last Page
3-3. Voltmeter Circuit	22	* Yellow Change Notice sheet is included only for instrument modifications affect- ing the Instruction Manual.	
3-4. Ammeter Operation	24		
3-5. Ohmmeter Operation	24		
3-6. Coulombmeter Operation	25		
3-7. Power Supply	26		
4. MAINTENANCE	29		
4-1. General	29		
4-2. Parts Replacement	29		
4-3. Troubleshooting	29		
4-4. Procedures to Guide Trouble- shooting	30		
4-5. 234-Volt Operation	32		



FIGURE 1. Keithley Instruments Model 610B Electrometer.

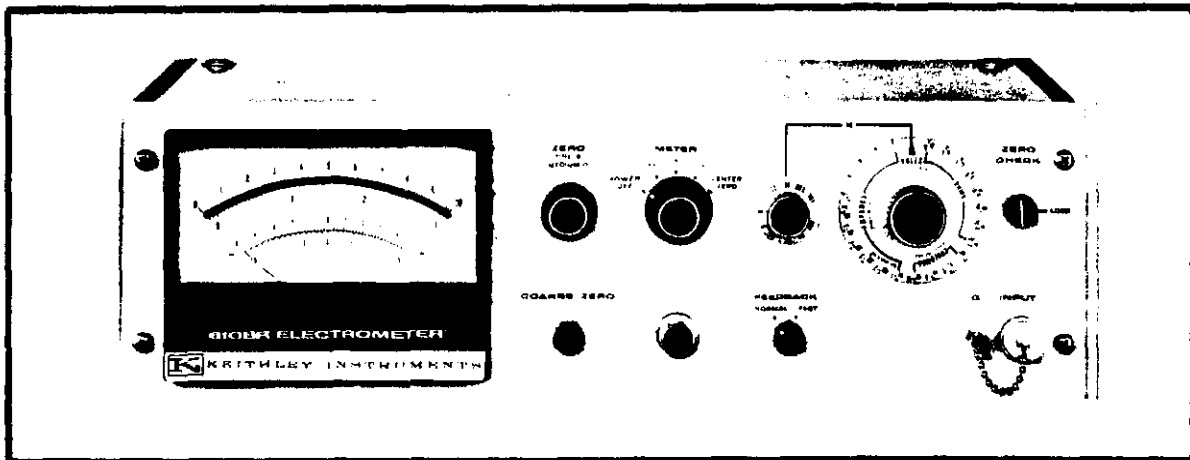

FIGURE 2. Keithley Instruments Model 610BR Electrometer. Model 610BR is the rack version of the Model 610B.

SECTION 1. GENERAL DESCRIPTION

1-1. GENERAL.

a. The Keithley Model 610B Electrometer is a versatile instrument which measures wide ranges of dc voltages, currents, resistances and charges. It is a highly improved form of conventional dc vacuum tube voltmeters that uses an electrometer tube input to provide greater than 10^{14} ohm input resistance. The Model 610B has all the capabilities of conventional VTVMs, but it can also make many more measurements without loading circuits.

b. The Electrometer has 11 voltage ranges from 0.001 volt full scale to 100 volts, 28 current ranges from 10^{-14} ampere full scale to 0.3 ampere, 25 linear resistance ranges from 100 ohms full scale to 10^{14} ohms, and 15 coulomb ranges from 10^{-12} coulomb full scale to 10^{-5} coulomb.

c. The Model 610B input stage uses a matched pair of electrometer tubes. The output stage uses a vacuum tube; otherwise, solid-state devices are used for all amplifier stages and the power supply. This increases reliability and stability and allows greater regulation of the power supply.

1-2. FEATURES.

a. Voltmeter accuracy is $\pm 1\%$ of full scale, exclusive of noise and drift.

b. Zero drift of the Model 610B is 200 microvolts per hour maximum averaged over any 24-hour period after warm-up. During the 2-hour warm-up, zero drift is no more than 2 millivolts after the first hour.

c. Two amplifier outputs are available. A switch on the rear panel allows either ± 3 volts or ± 1 milliampere for full-scale meter deflection. The current output is variable $\pm 5\%$ with 1.4-kilohm recorders. The unity-gain amplifier output is equal to the input voltage within 50 ppm or 100 microvolts, exclusive of zero drift.

d. Current measurements can be made by one of two methods, the normal method in which the current is determined by measuring the voltage drop across a resistor shunting the input, or the fast method in which negative feedback is applied through the shunt resistor. The latter method reduces the input drop and greatly increases the response speed on the low-current ranges.

1-3. DIFFERENCES BETWEEN THE MODELS 610B AND 610BR.

a. The Model 610BR is the rack version of the cabinet configuration, Model 610B. The circuits, specifications, electrical parts and operating procedures for the two models are the same. Besides the outside dimensions, the main difference between them is the Model 610BR's COARSE ZERO Control is on the front panel, not on the rear panel.

b. The instructions in the Manual are for both models, although only the Model 610B is mentioned. Any differences are identified for the correct model.

1-4. SPECIFICATIONS.

AS A VOLTMETER:

RANGE: .001 volt full scale to 100 volts in eleven 1x and 3x ranges.

ACCURACY: $\pm 1\%$ of full scale on all ranges exclusive of noise and drift.

ZERO DRIFT: After 1-hour warm-up no more than 2 millivolts in the second hour, and in any subsequent 24-hour period, the average drift will not exceed 200 microvolts per hour.

METER NOISE: ± 10 microvolts with input shorted.

INPUT IMPEDANCE: Greater than 10^{14} ohms shunted by 22 picofarads on the VOLTS position of the Range Switch. Input resistance may be selected in decade steps from 10 to 10^{11} ohms with the Range Switch.

AS AN AMMETER:

RANGE: 10^{-14} ampere full scale to 0.3 ampere in twenty-eight 1x and 3x ranges.

ACCURACY: $\pm 2\%$ of full scale on 0.3 to 10^{-11} ampere ranges using smallest available Multiplier Switch setting; $\pm 4\%$ of full scale on 3×10^{-12} to 10^{-14} ampere ranges.

METER NOISE: Less than $\pm 3 \times 10^{-15}$ ampere.

GRID CURRENT: Less than 2×10^{-14} ampere.

AS AN OHMMETER:

RANGE: 100 ohms full scale to 10^{14} ohms on twenty-five linear 1x and 3x ranges.

ACCURACY: $\pm 3\%$ of full scale on 100 to 10^9 ohm ranges using highest available Multiplier Switch setting; $\pm 5\%$ of full scale on 3×10^9 to 10^{14} ohm ranges.

AS A COULOMB METER:

RANGE: 10^{-12} coulomb full scale to 10^{-5} coulomb in fifteen 1x and 3x ranges.

ACCURACY: $\pm 5\%$ of full scale on all ranges. Drift due to grid current does not exceed 2×10^{-14} coulomb per second.

AS AN AMPLIFIER:

INPUT IMPEDANCE: Greater than 10^{14} ohms shunted by 22 picofarads on the VOLTS position of the Range Switch. Input resistance may be selected in decade steps from 10 to 10^{11} ohms with the Range Switch.

OUTPUTS: Unity-gain output and either voltage or current recorder output.

Unity-Gain Output: At dc, output is equal to input within 50 ppm or 100 microvolts, exclusive of zero drift, for output currents of 100 microamperes or less. Up to one milliamperes may be drawn for input voltages of 10 volts or less.

Voltage Recorder Output: ± 3 volts for full-scale input. Internal resistance is 3 kilohms. Output polarity is opposite input polarity.

Gain: 0.03, 0.1, etc., to 3000.

Frequency Response (Within 3 db): dc to 300 cps at a gain of 3000, rising to 25 kc at a gain of 30, decreasing to 2.5 kc at a gain of 0.03.

Noise: 3% rms of full scale at a gain of 3000, decreasing to 1% at gains below 100.

Current Recorder Output: ± 1 milliamperes for full-scale input, variable $\pm 5\%$ with 1400-ohm recorders.

GENERAL:

POLARITY: METER Switch selects left zero (positive or negative) or center-zero scales. Output polarity is not reversed.

LINE STABILITY: A 10% change in line voltage will cause less than a 10-microvolt meter deflection on all ranges.

CONNECTORS: Input: uhf type; ground binding post.
Output: Voltage or current, Amphenol 80-PC2F; Unity-gain, binding posts.

POWER: 105-125 or 210-250 volts (switch selected); 50 to 1000 cps; 10 watts.

DIMENSIONS, WEIGHT: Model 610B: 10-1/2 inches high x 6-5/8 inches wide x 10 inches deep; net weight, 12 pounds. Model 610BR: 5-1/4 inches high x 19 inches wide x 10 inches deep; net weight, 12 pounds.

ACCESSORIES SUPPLIED: Mating input and output plugs; 3:2 power line adapter; binding plug.

1-5. APPLICATIONS.

a. Voltmeter applications include directly measuring potentials of vacuum tube plates and grids, pH electrodes, piezo-electric crystals, capacitors and electrochemical cells, and the gate potentials of field effect transistors. With the Model 2501 or 2503 Static Detector Probe, the Model 610B can measure electrostatic voltages.

b. As a picoammeter, the Electrometer can measure mass spectrograph currents. It can be used with photo multiplier tubes, flame and beta ray and lithium ion-drift detectors. Other uses are in gas chromatograph work, nuclear studies, plasma physics studies and vacuum studies. Also, it can be used as a current null detector with an accurate current reference source.

c. As an ohmmeter, its uses include measuring diode characteristics, insulation resistance, and resistor voltage coefficients. With the Model 6105 Resistivity Adapter and a power supply, the Model 610B can measure volume and surface resistivities.

d. In addition to measuring charge directly, other coulombmeter uses are measuring charge current over a period and obtaining integral curves of time-varying currents. The Model 610B can measure the total energy output from a pulsed laser on its coulomb ranges when used with a calibrated photo tube or photo diode. It also can be used as a charge amplifier to measure piezo-electric crystal outputs.

1-6. ACCESSORIES.

a. Three accessory probes, fully described in Section 5, facilitate measurements and extend the Electrometer's voltage range to 30 kilovolts.

b. Model 6104 Test Shield is suitable for resistance measurements with either 2 or 3-terminal guarded connections, as well as voltage and current tests.

c. Model 6105 Resistivity Adapter is a guarded test fixture for measuring volume and surface resistivities of materials when used with the Model 610B and the Keithley Model 240A High Voltage Supply.

d. Models 2501 and 2503 Static Detector Probes are capacitive voltage dividers with a 10,000:1 ratio, when used with the probe 3/8 inch from the charged surface.

e. Model 6106 Electrometer Connection Kit contains a group of the most useful leads and adapters for electrometer measurements.

f. Model 6107 pH Electrode Adapter has a 2-foot cable and coaxial connector and accepts a Beckman and Coleman (B-C) or a Leeds and Northrup (L & N) connector. The Adapter allows accurate and convenient pH potential measurements with the Model 610B.

g. Model 370 Recorder is uniquely compatible with the Model 610B as well as other Keithley microvoltmeters, electrometers and picoammeters. The recorder is a high quality economical instrument that maximizes the performance of the Model 610B and many other Keithley instruments, even in the most critical applications.

1-7. EQUIPMENT SHIPPED. The Model 610B Electrometer is factory-calibrated and is shipped with all components in place. The shipping carton contains the Instruction Manual and mating plugs for the input and output receptacles. The Model 610BR is shipped with the angles and screws for rack mounting packed separately within the shipping carton.

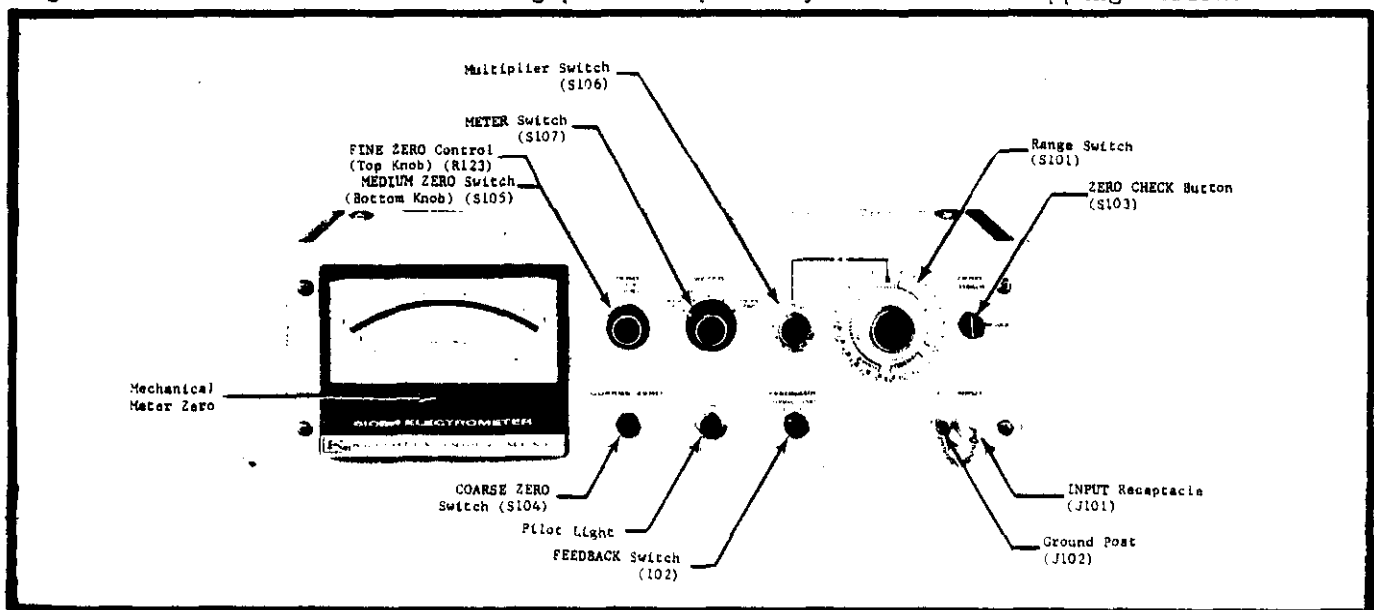

FIGURE 3. Model 610BR Front Panel Controls and Terminals. Circuit designations refer to Replaceable Parts List and the schematic diagram.

SECTION 2. OPERATION

2-1. FRONT PANEL CONTROLS AND TERMINALS (See Figures 3 and 4).

a. Range Switch. The Range Switch selects the measuring mode and the range. It is divided into a VOLTS position, 11 AMPERES ranges, eight OHMS ranges and four COULOMBS ranges. The range used is indicated by an X above the dial skirt.

b. Multiplier Switch. The Multiplier Switch determines the voltage sensitivity of the dc amplifier and sets the full-scale voltage range when the Range Switch is set to VOLTS. The Multiplier Switch may also be used to multiply the AMPERES (3x maximum setting above 10^{-3}), OHMS and COULOMBS ranges on the Range Switch.

c. METER Switch. The Switch has five positions: POWER OFF shuts off the instrument. OFF disconnects only the meter during recorder operation. The + and - positions determine the polarity of the meter. CENTER ZERO sets the instrument for center zero operation (lower meter scale).

d. ZERO Controls. Two ZERO Controls are on the front panel: a MEDIUM Switch (outer knob) and a 10-turn FINE potentiometer (center knob). These allow precise meter zeroing.

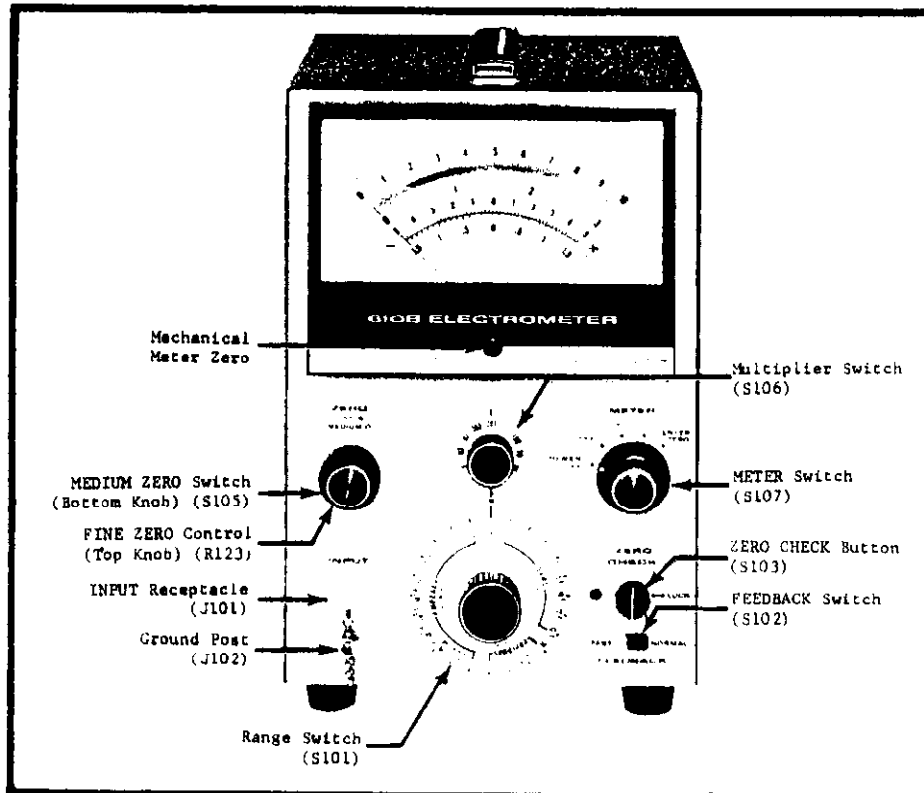

FIGURE 4. Model 610B Front Panel Controls and Terminals. Circuit designations refer to Replaceable Parts List and the schematic diagram.

e. ZERO CHECK Button. Depressing the Button effectively removes all input signal from the instrument by shunting the input and amplifier through 10 megohms. This allows meter zeroing on any range. The Button is locked in the zero check position when the line is horizontal.

f. FEEDBACK Switch. The FAST and NORMAL positions of the Switch determine the feedback connections within the instrument. Voltage measurements are made only in NORMAL. With the Switch at FAST, current measurements are made with lower input voltage drops and faster response speeds. The FAST position is also used to make guarded resistance measurements, for coulomb measurements, and to increase response speed.

g. INPUT Receptacle. The INPUT Receptacle is a Teflon-insulated uhf-type connector. A dust cap is provided. The ground post is below the receptacle.

2-2. REAR PANEL CONTROLS AND TERMINALS (See Figure 5).

a. COARSE ZERO Switch (On front panel of Model 610BR). The COARSE ZERO Switch has 11 positions to extend the zeroing capability of the front panel ZERO Controls.

b. Output Switch. The Switch is a two-position slide switch for the output. In the 1 MA position, the instrument will drive 1-milliampere recorders. In the 3 V position, the output is 3 volts for full-scale meter deflection. Source resistance is 3 kilohms.

c. 1 MA CAL Control. The Control varies the output from 0.95 to 1.05 milli-ampere for 1400-ohm recorders, so the recorder scale will correspond with the Electrometer panel meter.

d. OUTPUT Receptacle. A 2-terminal microphone-type receptacle provides 3 volts or 1 milliampere for full-scale meter deflection. Pin no. 2 is at case ground potential if the FEEDBACK Switch is at NORMAL.

e. X1 OUTPUT and GUARD Terminals. The potential between the X1 OUTPUT Terminal and the GUARD Terminal (case ground for the FEEDBACK Switch in NORMAL) is equal to the input voltage with 0.005% linearity or 100 microvolts. When the FEEDBACK Switch is at FAST, the X1 OUTPUT Terminal is at case ground and the GUARD Terminal is floating.

f. FUSE. For 105-125 volt operation, use a 1/4 ampere, 3 AG Slow Blow fuse. For 210-250 volt operation, use a 1/8 ampere, 3 AG Slow Blow fuse.

g. 117-234 Switch. The screwdriver-operated slide switch sets the Model 610B for 117 or 234-volt ac power lines.

h. Power Cord. The 3-wire power cord with the NEMA approved 3-prong plug provides a ground connection for the cabinet. An adapter for operation from 2-terminal outlets is provided.

2-3. INPUT CONNECTIONS.

a. The accessories described in Section 5 are designed to increase the

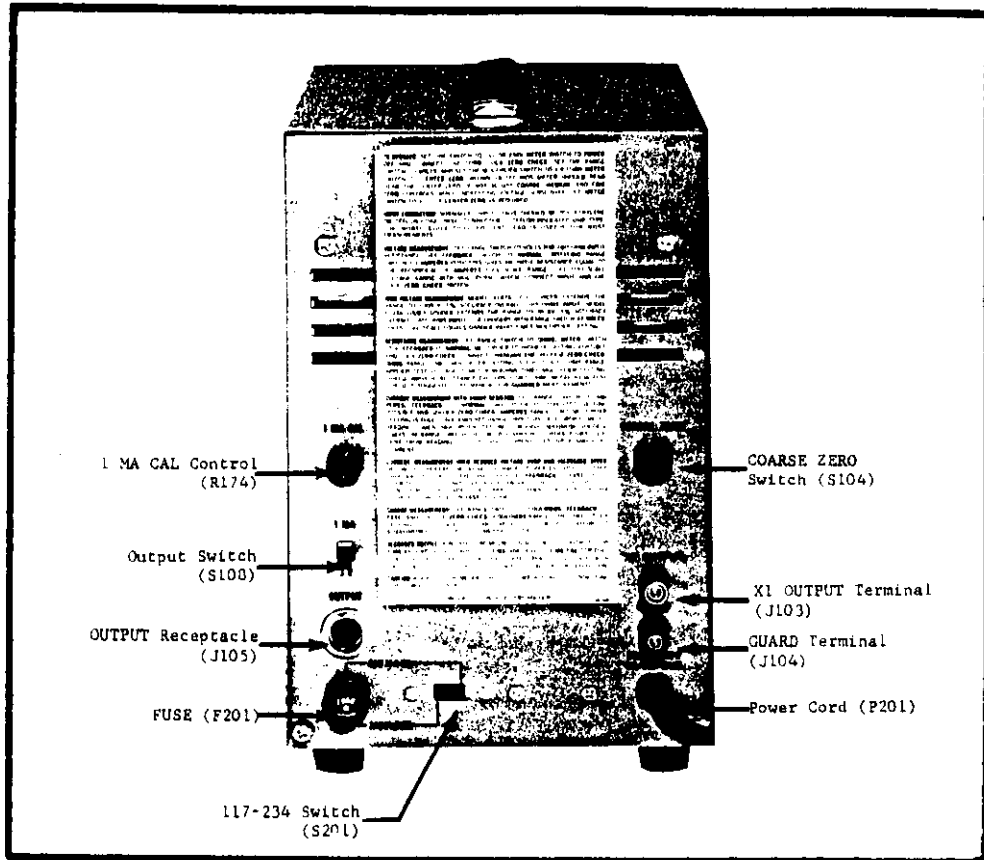

FIGURE 5. Model 610B Rear Panel Controls and Terminals. Circuit designations refer to Replaceable Parts List and the schematic diagram.

accuracy and convenience of input connections. Use them to gain the maximum capability of the Model 610B.

NOTE

Using the accessories and coaxial cables is the best way to make input connections.

b. Carefully shield the input connection and the source being measured, since power line frequencies are well within the pass band of the Electrometer. Unless the shielding is thorough, any alteration in the electrostatic field near the input circuitry will cause definite meter disturbances.

c. Use high resistance, low-loss materials — such as Teflon (recommended), polyethylene or polystyrene — for insulation. The insulation leakage resistance of test fixtures and leads should be several orders magnitude higher than the internal resistance of the source. If it is not, leakage losses will cause lowered readings. Coaxial cables used should be a low-noise type which employ a graphite or other conductive coating between the dielectric and the surrounding shield braid. Amphenol-Borg Electronics Corporation, Microdot, Inc., and Simplex Wire and Cable Company make satisfactory types.

Using the Model 6101A Probe is a simple way to insure good input connections.

NOTE

Clean and dry connections and cables are very important to maintain the value of all insulation materials.

d. Any change in the capacitance of the measuring circuit to ground will cause extraneous disturbances. Make the measuring setup as rigid as possible, and tie down connecting cables to prevent their movement. If a continuous vibration is present, it may appear at the output as a sinusoidal signal and other precautions may be necessary to isolate the instrument and the connecting cable from the vibration.

e. For low impedance measurements, unshielded leads and a binding post adapter may be used. However, keep the leads short.

f. When measuring currents 10^{-14} ampere or less with the FEEDBACK Switch at FAST, some insulators — such as Teflon — may produce random signals which show up as erratic meter deflections. Insulation used in the Model 610B is carefully selected to minimize these signals.

g. Connect the Model 610B to the circuit only when a reading is being made. In some cases, the grid current can charge the external test circuitry when it is connected to the Electrometer input. One example is measuring a capacitor's leakage resistance by observing the decay of its terminal voltage. If the leakage current is less than the grid current, there is no decay of the terminal voltage when the electrometer is left connected across the capacitor's terminals. Instead, there is a build-up which seems to indicate that the capacitor dielectric has a negative resistance.

NOTE

Techniques and applications are thoroughly discussed in the brochure, Electrometer Measurements, by Joseph F. Keithley. It is available by writing to Keithley Instruments, Inc.

2-4. Preliminary Procedures.

a. Check the 117-234 Switch and the Fuse for the proper ac line voltage.

NOTE

Make sure METER Switch is set to POWER OFF before connecting or disconnecting the power cord.

b. Set the controls as follows:

METER Switch	POWER OFF
Range Switch	VOLTS
Multiplier Switch	1
FEEDBACK Switch	NORMAL
ZERO CHECK Button	LOCK

c. Connect the power cord and turn the METER Switch to CENTER ZERO. Within ten seconds, the meter pointer should come to the center zero position. If not, adjust to meter zero with the MEDIUM and FINE ZERO Controls. Normally, there is no need to use the COARSE ZERO Switch.

d. After a few moments increase the voltage sensitivity by advancing the Multiplier Switch to .3, .1, etc. Continue zeroing with the FINE ZERO Control.

NOTE

Always turn the Model 610B off using the METER Switch. Do not shut the instrument off by disconnecting the power cord or otherwise externally shutting off the power supply. If it must be turned off externally, set the Multiplier Switch to 1 or lower. If these cautions are not followed, the Electrometer may drift for several hours when it is used again.

e. After long periods of storage or after an overload, the Model 610B may drift excessively. Although the electrometer tubes are shock mounted, a severe jolt can also cause a zero offset. This is corrected with the Zero Controls. Drifting, however, can occur for a few hours.

f. Although the grid current of the Electrometer is much below that found in conventional voltmeters, it can be observed on the meter. A small voltage results from the grid current charging the input capacity, and the Electrometer appears to drift when the input is open. Use the ZERO CHECK Button to discharge the build-up.

NOTE

Keep the protective cap on the INPUT Receptacle when the Electrometer is not in a circuit.

g. Follow the particular procedures for measuring voltage, current, resistance and charge in the next four paragraphs.

2-5. Voltage Measurements.

a. The Model 610B's high input impedance allows circuit measurements without causing circuit loading. For low resistance in-circuit tests, the input resistance can be lowered to avoid pick-up problems.

NOTE

Make all voltage measurements with the FEEDBACK Switch only in the NORMAL position.

b. High Impedance Measurements (10^{14} ohms, 22 picofarads). Follow the instructions of paragraph 2-4. Set the controls as follows:

METER Switch	CENTER ZERO
Range Switch	VOLTS
Multiplier Switch	100
FEEDBACK Switch	NORMAL
ZERO CHECK Button	LOCK

Connect the unknown source to the INPUT Receptacle and unlock the ZERO CHECK Button. Set the METER Switch to + or -, as necessary. Increase the sensitivity with the Multiplier Switch. Recheck the zero setting after increasing the sensitivity.

c. Low Impedance Measurements. To decrease the input resistance from 10^{14} ohms, set the Range Switch to one of the AMPERES ranges. The input resistance is now the reciprocal of the current range. For instance, to obtain an input resistance of 10^7 ohms — which is normal for conventional VTVMs — set the Range Switch to the 10^{-7} AMPERES range. Set the full-scale voltage range with the Multiplier Switch. Operating procedures are the same as subparagraph b above.

d. To measure sources more than 100 volts, use the Model 6102A 10:1 Divider Probe or the 6103A 1000:1 Divider Probe. The Model 6102A extends the Model 610B's range to 1000 volts; overall accuracy is $\pm 3\%$ and input resistance is 10^{10} ohms. The Model 6103A extends the Model 610B's range to 30 kilovolts; overall accuracy is $\pm 5\%$ and input resistance is 10^{12} ohms. Follow the same operating procedures with the dividers as in subparagraph b. The full-scale voltage range is the divider ratio times the Multiplier Switch setting.

NOTE

Accuracy decreases 0.5% when the center zero scales are used because the scale span is shorter.

2-6. Current Measurements.

a. The Model 610B can measure currents three ways.

1. In the normal method — used on any range — the current is determined by measuring the voltage drop across a resistor shunting the amplifier input. This method is useful when lower noise is more important than faster response speeds or if some damping is needed.

2. In the fast method — for use only below the 10^{-5} ampere range — the shunt resistor is between the amplifier output and input in the feedback loop. This circuit largely neutralizes the effect of input capacity and greatly increases the response speed. Also, the input voltage drop is reduced to a maximum of one millivolt on any range.

3. For galvanometric current measurements, the Model 610B acts as a null indicator between a very accurate current source and the unknown current source.

b. Rise time varies primarily with the current range, the input capacity and the method used. On most ranges, the rise time is less than one second with 50 picofarads across the input. Even with much larger shunt capacities, the negative feedback maintains a short rise time. Given a choice, it is better to place the Electrometer near to the current source than to the data reading instrument. Transmitting the input signal through long coaxial cables greatly decreases the response speed and increases noise due to the cable capacitance.

c. Normal Method (0.3 to 10^{-14} ampere ranges).

1. Follow the instructions of paragraph 2-4. Set the controls as follows:

METER Switch	CENTER ZERO
Range Switch	10^{-1} AMPERES
Multiplier Switch	1
FEEDBACK Switch	NORMAL
ZERO CHECK Button	LOCK

Connect the unknown source to the INPUT Receptacle and unlock the ZERO CHECK Button. Set the METER Switch to + or -, as necessary. Increase the sensitivity with the Range Switch and the Multiplier Switch. Do not set the Multiplier Switch higher than 3 for Range Switch settings 10^{-3} and above. Check zero with the ZERO CHECK Button.

2. The full-scale current range is the Range Switch setting times the Multiplier Switch setting. Use the smallest Multiplier Switch setting possible to obtain the best accuracy. The input resistor varies with the Range Switch setting, from 10 ohms at 10^{-1} AMPERES to 10^{11} ohms for 10^{-11} AMPERES. The input voltage drop is the meter reading times the Multiplier Switch setting.

3. On the 10^{-9} to 10^{-11} AMPERES settings of the Range Switch, the high-megohm resistors used have a voltage coefficient of a nominal .02% per volt. If the input voltage drop reaches 100 volts, an error of $100 \times .02\%$ or 2% occurs to lower the specified accuracy. Therefore, use a low Multiplier Switch setting — best is 0.1 to 1 — so neither voltage coefficient nor zero stability presents a problem.

NOTE

On the low current ranges, balance out the grid current with the Zero Controls or subtract the value from the reading. To find the amount of grid current, cap the INPUT Receptacle and read the meter.

d. Fast Method (ranges below 10^{-5} ampere).

1. Follow the instructions of paragraph 2-4. Set the controls as follows:

METER Switch	CENTER ZERO
Range Switch	10^{-6} AMPERES
Multiplier Switch	1
FEEDBACK Switch	FAST
ZERO CHECK Button	LOCK

Connect the unknown source to the INPUT Receptacle and unlock the ZERO CHECK Button. Set the METER Switch to + or -, as necessary. Increase the sensitivity with the Range Switch and the Multiplier Switch. Do not set the Range Switch to 10^{-5} AMPERES or higher. Check zero with the ZERO CHECK Button.

NOTE

Use only the ZERO CHECK Button to check zero for the fast method. Do not short the input, because this will remove the feedback from the circuit.

2. The full-scale current range is the Range Switch setting times the Multiplier Switch setting. When selecting the Multiplier Switch setting, remember small settings permit lower current source resistance, and larger settings improve instrument zero stability. Check the caution in subparagraph 3a below.

3. With the fast method, the input drop is reduced and the response speed is increased at least 100 times. However, follow these cautions:

a) The internal impedance of the unknown current source should not be less than .1 of the value of the feedback resistor being used. Otherwise, the full feedback voltage cannot be developed at the input, and zero instability results. The feedback resistor value is the reciprocal of the AMPERES range of the Range Switch.

b) The low side of the OUTPUT Receptacle is no longer grounded. Therefore, do not ground recorders or oscilloscopes to the Electrometer's case, such as through the ground lead of the power cord. Another alternative is using the unity-gain output (paragraph 2-10).

c) Do not use the fast method to measure capacitor leakages. Connecting a capacitor to the input causes the circuit to be transformed into a differentiator, resulting in extreme sensitivity to very small voltage transients.

e. Galvanometric Method.

1. Operate the Model 610B as a picoammeter in the fast method of operation. Use an accurate reference current source to buck out the unknown current source. Connect as shown in Figure 6.

2. Set the METER Switch to CENTER ZERO and use the higher current ranges. Adjust the buckout current to indicate null on the Model 610B. Increase the Electrometer's sensitivity as needed. When the Model 610B is as close to null as possible, the known reference current source equals the unknown source \pm the Model 610B current reading.

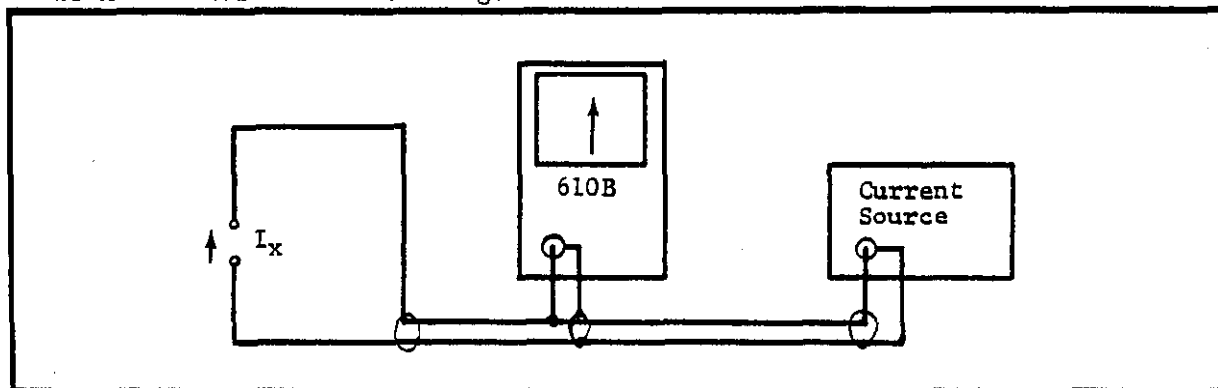

FIGURE 6. Measuring Current by the Galvanometric Method. Use an accurate reference current source to buckout the unknown current source, I_x . The Model 610B, on its current ranges, serves as a null detector. Use a uhf-tee fitting at the Model 610B input. Connect the Electrometer to the two sources with coaxial cable. Select cable carefully for very low currents (see paragraph 2-3).

2-7. Resistance Measurements.

a. The Model 610B can measure resistances by three methods.

1. In the normal or two-terminal method (ammeter-voltmeter), the Electrometer measures the voltage drop across the unknown sample as a known, constant current flows through it. The voltage drop is proportional to the resistance of the sample. This method is the simplest for the 100 to 10^{11} ohm ranges.

2. Above 10^{11} ohms or to prevent leakage, the guarded method is better. It results in faster response speeds and also nullifies leakage errors across the Electrometer input, since the potential across the input terminal is small.

3. In the preceding methods, the voltage across the sample cannot be arbitrarily set. In some cases, as in measuring capacitor leakage, these methods involve much more time than if a larger voltage could be applied. In the external voltage method the Model 610B is used as a fast picoammeter. The unknown resistance sample is connected to an external known voltage source and the current through the sample is measured. Either the normal or fast method may be used. The resistance is calculated from the readings.

NOTE

Discharge any capacitor before removing it from the circuit. Depressing the ZERO CHECK Button shorts the input through a 10-megohm resistor, providing a discharge path.

b. Normal Method (100 to 10^{11} ohm ranges).

1. Follow the instructions of paragraph 2-4. Set the controls as follows:

METER Switch	+
Range Switch	10^5 OHMS
Multiplier Switch	1
FEEDBACK Switch	NORMAL
ZERO CHECK Button	LOCK

Connect the resistance sample to the INPUT Receptacle. Unlock the ZERO CHECK Button. Check zero with only the ZERO CHECK Button.

NOTE

Do not open-circuit the Electrometer on the OHMS ranges; the input will develop a large voltage due to its constant current characteristic. Keep the input shorted or the ZERO CHECK Button locked.

2. The full-scale ohms range is the Range Switch setting times the Multiplier Switch setting. Use the largest Multiplier Switch setting possible to obtain the best accuracy.

3. Before making a final reading, manipulate the Multiplier and Range Switches, so the sample is tested at a number of test potentials. The applied test voltage is the meter reading times the Multiplier Switch setting.

NOTE

Shield the input if the resistance sample exceeds one megohm.

c. Guarded Method (to 10^{14} ohm ranges).

1. Follow the instructions of paragraph 2-4. Set the controls as follows:

METER Switch	+
Range Switch	10^{11} OHMS
Multiplier Switch	1
FEEDBACK Switch	FAST
ZERO CHECK Button	LOCK

Connect the low impedance side of the resistance sample to the Model 610B GUARD Terminal, and the high impedance side to the INPUT Receptacle. Unlock the ZERO CHECK Button.

2. Read the resistance as outlined for the normal method, subparagraph b.

d. External Voltage Method (To 10^{16} ohms).

1. Turn the ZERO CHECK Switch to LOCK. Connect the sample between the INPUT Receptacle and the power supply. (See Figure 7.) Put a switch in the high voltage line to ground the low impedance end of the sample when it is disconnected from the potential.

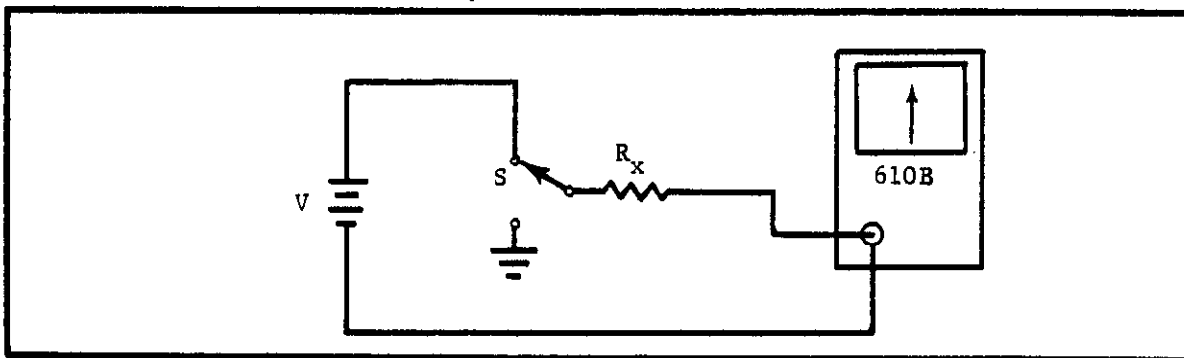

FIGURE 7. Measuring Resistance by the External Voltage Method. A potential from a known source, V , is applied to the unknown resistance sample, R_x . The Model 610B measures the current through R_x , from which the resistance is calculated. Switch S grounds R_x when no potential is applied.

2. Set the FEEDBACK Switch to NORMAL. Usually this method is best, since instabilities can arise if the resistance sample is less than .1 the value of the feedback resistor.

3. Apply a potential to the sample before releasing the ZERO CHECK Button. Set the Range Switch to .3 AMPERES and increase sensitivity until a reading is obtained.

4. If the potential applied is at least 100 times the full-scale input drop (Multiplier Switch setting), the resistance is equal to the applied potential divided by the current reading. The high voltage sensitivity of the Model 610B, therefore, permits external voltages of .1 volt or more to be used.

5. If the potential applied is less than 100 times the input drop, the resistance is equal to the difference between the applied potential and the input drop, all divided by the current reading.

6. If the current is read by the fast method, the input drop is so slight that it need not be included in the calculation. If the capacity shunted across the sample is large, such as encountered in capacitor leakage measurements, the fast method increases response speed and this connection is recommended.

2-8. Charge Measurements.

a. Follow the instructions of paragraph 2-4. Set the controls as follows:

METER Switch	CENTER ZERO
Range Switch	10^{-7} COULOMBS
Multiplier Switch	.01
FEEDBACK Switch	FAST
ZERO CHECK Button	LOCK

Unlock the ZERO CHECK Button and then connect the unknown source to the INPUT Receptacle. If the Electrometer reads off scale, increase the Multiplier Switch setting. If the sensitivity is not enough, decrease the Multiplier Switch setting until the reading is on scale. Changing the Multiplier Switch setting does not affect the transfer of charge from the unknown source to the instrument. If increasing sensitivity with the Multiplier Switch does not bring the reading on scale, increase sensitivity with the Range Switch and repeat the above steps.

b. The full-scale charge range is the Range Switch setting times the Multiplier Switch setting. Grid current contributes 2×10^{-14} coulomb per second maximum.

NOTE

Because of the instrument's RC time constant, wait 20 seconds after discharging internal capacitance on the 10^{-7} coulomb range before making another measurement. On the 10^{-8} coulomb range, wait at least two seconds.

2-9. Recorder Outputs.

a. For recording with the Model 610B, use the Keithley Model 370 Recorder for ease, economy, versatility and performance. The Model 370 is a pen recorder with 10 chart speeds and 1% linearity. The Model 370's input cable has a connector which mates directly with the OUTPUT Connector on the Model 610B; this avoids interface problems often encountered between a measuring instrument and a recorder. No special wiring is needed. No recorder preamplifier is required. (See paragraph 5-8 for more on the Model 370.)

b. Other recorders, oscilloscopes and similar instruments can be used with the Model 610B. The Model 610B has two variable gain outputs, ± 3 volts and ± 1 milliamperes, to amplify signals within 1/2% for recorders, oscilloscopes and similar instruments. These can be used on all ranges of the Model 610B.

c. 3-Volt Output. Connect oscilloscopes and pen recorder amplifiers to the OUTPUT Receptacle. Pin no. 1 is the negative terminal; pin no. 2 is grounded. Set the Output Switch to 3 V. The Model 610B output is now ± 3 volts for full-scale meter deflection on any range. Internal resistance is 3 kilohms. The frequency response (± 3 db) is dc to 300 cps at a gain of 3000, rising to 25 kc at a gain of 30, and decreasing to 2.5 kc at a gain of 0.03. Noise is 3% rms of full scale at a gain of 3000, decreasing to 1% at gains below 100. The METER Switch does not reverse the output polarity.

NOTE

The Model 610B may be used with the FEEDBACK Switch in FAST position with other instruments. However, make sure there is no common ground between the Electrometer case and the other instrument.

d. 1-Milliampere Output. Connect 1-milliampere instruments, such as Esterline Angus, General Electric or Texas Instrument Rectiriter, to the OUTPUT Receptacle. Pin no. 1 is the negative terminal. Set the Output Switch to 1 MA. The output is approximately 1 milliampere for full-scale meter deflection on any range. For exact output, adjust the meter on the .003-volt range with the FINE ZERO Control for full-scale deflection. Then adjust the 1 MA CAL Control until the recorder reads full scale. Check the recorder and meter zero and repeat adjustment if necessary. The METER Switch does not reverse the output polarity.

e. For servo rebalance recorders, use a divider across the Model 610B OUTPUT Receptacle. See Figure 8. Set the Output Switch to 1 MA. Use the 1 MA CAL Control to trim the output for full-scale recorder deflection. Operation is the same as for current outputs.

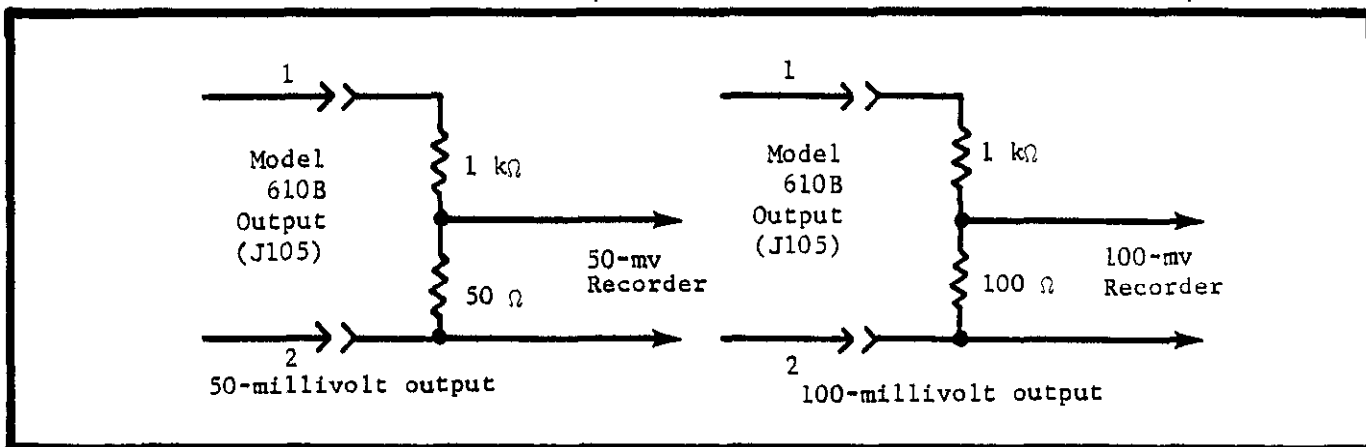

FIGURE 8. Divider Circuits Across Model 610B Output. The dividers are for driving 50 and 100-millivolt recorders. Use 1% resistors in the dividers.

f. When the FEEDBACK Switch is in the NORMAL position, the negative side of the output terminal is grounded to the instrument case. Therefore, no difficulty will be experienced using oscilloscopes and recorders with the Model 610B set for normal operation. In FAST position, however, neither side is grounded. If this is used, make sure there is no common ground between the recorder or oscilloscope and the Model 610B case, or use the unity-gain output.

2-10. Unity-Gain Output.

The unity-gain amplifier can be used as an impedance matching device to minimize circuit loading errors or for convenient connections to a recorder when the FEEDBACK Switch is in FAST position.

a. The unity-gain output is equal to the input within 50 ppm or 100 microvolts when the load resistance is 100 kilohms or better below 10 volts or 1 megohm or better above 10 volts. By placing the Model 610B between a 10^{10} ohm source, for example, and a 0.01% voltmeter with a 1-megohm input resistance, overall accuracy better than 0.025% can be achieved.

1. Connect the voltmeter to the X1 OUTPUT and GUARD Terminals as shown in Figure 9. The GUARD Terminal is at ground with the FEEDBACK Switch in NORMAL. Maximum output amplitude is 100 volts peak-to-peak.

2. Adjust the Model 610B Zero Controls to obtain a zero-voltage reading on the instrument using the unity-gain output. Make sure the latter's sensitivity is high enough for a precise zero adjustment. This adjustment is necessary because a slight zero shift may occur when the Model 610B is changed from the 0.1-volt range or lower to a range above 0.1 volt. The shift, caused by a gain-reducing network switched in by the amplifier on the 0.3-volt and higher ranges, is too slight to be read on the meter, but it can cause an error in accurate measurements using the unity-gain output.

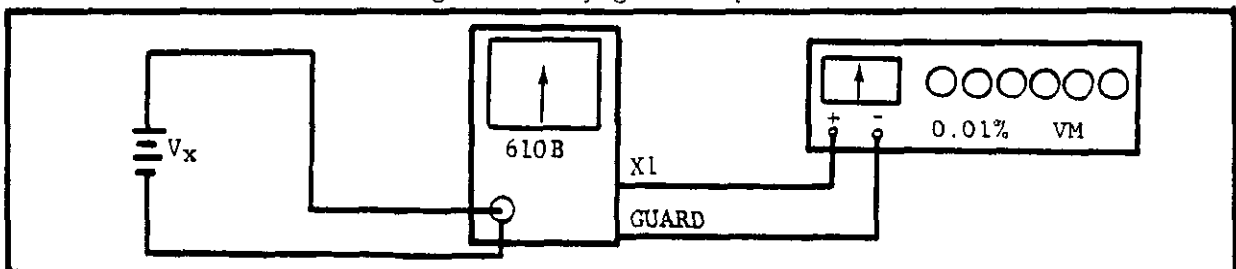

FIGURE 9. Measuring Potential of High Resistance Source with 0.025% Accuracy. The Model 610B is used between a high-resistance source, V_x , and a 0.01% voltmeter to obtain high accuracy without causing circuit loading. The digital voltmeter or, as above, the Keithley Model 662 Differential Voltmeter connects to the Model 610B unity-gain terminals.

b. When the FEEDBACK Switch is in FAST position, the unity-gain terminals permit more convenient connections to recorders without special precautions. In this mode, the X1 OUTPUT Terminal is grounded and the GUARD Terminal delivers a full-scale output equal to the Multiplier Switch setting or the input.

2-11. CURRENT SOURCE. The Model 610B can be used as a $\pm 4\%$ current source from 10^{-5} to 10^{-11} ampere. Follow these procedures:

a. Set the FEEDBACK Switch to NORMAL, the Range Switch to OHMS and the METER Switch to + or -

b. The current supplied at the INPUT Receptacle is the reciprocal of the OHMS Setting on the Range Switch. (For example, 10^9 OHMS indicates 10^{-9} ampere current at the INPUT Receptacle.)

c. The Multiplier Switch does not affect the current at the INPUT Receptacle. It does affect the maximum input voltage drop, which is equal to the Multiplier

Switch setting. For accurate output current, check the meter zero on the .01-volt range.

2-12. **STATIC CHARGE MEASUREMENTS.** Electrometers are very sensitive to static charges and can readily make qualitative or quantitative measurements.

a. Zero the Model 610B; set the FEEDBACK Switch to NORMAL and the Range Switch to VOLTS (10 or 30 volts full scale). Bring the charged object near the uncovered, unshielded INPUT Receptacle. Depending upon the distance between the charge and the instrument, a voltage will be induced on the input terminals which can be read on the meter. Check zero frequently, since accumulation of charge due to the electrometer tube grid current will cause a slow drift of the input voltage.

b. Connecting a capacitor across the input reduces the drift due to grid current and also the sensitivity to charge. Therefore, set the Range Switch to COULOMBS position. The capacitor value connected across the input in farads is equal to the COULOMBS Range.

2-13. **CAPACITANCE MEASUREMENTS.** The Model 610B can measure capacitance from 500 picofarads to 100 microfarads. The Electrometer charges the capacitor to a known potential and then measures the charge. The resulting capacitance is easily figured.

a. Charge the capacitor as follows:

1. Set the Model 610B front panel controls to:

METER Switch	+
Range Switch	VOLTS
Multiplier Switch	.001 to 100
FEEDBACK Switch	NORMAL
ZERO CHECK Button	LOCK

2. Connect the unknown capacitor to the INPUT Receptacle. Unlock the ZERO CHECK Button and charge the capacitor to a known voltage by setting the Range Switch to the OHMS ranges. As the capacitor charges, the meter will advance up scale to show the voltage (meter reading times the Multiplier Switch setting) across the capacitor at any given time.

3. Charge the capacitor to a convenient voltage, such as 0.1, 1, 10, etc. Charge large capacitors to a lower voltage than that used for low value capacitors. The OHMS ranges control the charging rate: start with the lower ranges and increase the setting as the voltage across the capacitor reaches the desired value.

4. When the capacitor reaches the desired value, quickly set the Range Switch to the VOLTS position, then disconnect the capacitor from the INPUT Receptacle. Or, if more convenient, first disconnect the capacitor from the INPUT Receptacle, then set the Range Switch to the VOLTS position.

NOTE

Be careful handling charged capacitors. The Model 610B can charge a capacitor to 100 volts. If the capacitance is above 0.01 microfarad, a dangerous potential could exist.

b. Measure the charge on the capacitor following the instructions in paragraph 2-8.

c. The value of the unknown capacitance is the stored charge divided by the initial voltage:

$$C \text{ (farads)} = \frac{Q \text{ (coulombs)}}{V \text{ (volts)}}$$

2-14. APPLICATION NOTES. The versatility of the Model 610B is such that it is almost a complete dc laboratory in itself. Some particular applications follow; the purpose of these is to suggest uses and techniques to increase the usefulness of the Model 610B.

a. Current Integrator. The Model 610B works as an integrator for time-varying currents. Figure 10 shows the circuit. Set the Range Switch to COULOMBS. Use the unity-gain output. Output voltage, V_{out} , is

$$V_{out} = \frac{1}{C} \int_0^T i \, dt$$

where C is the coulomb range setting in farads.

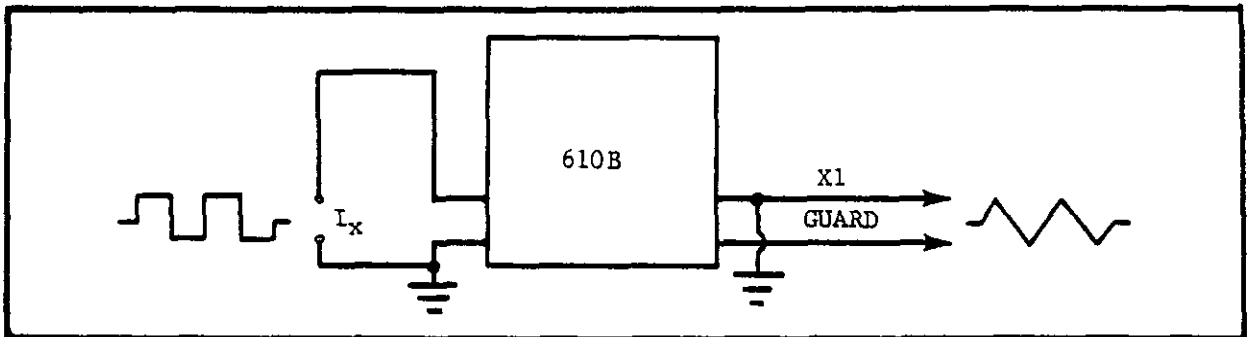

FIGURE 10. Current Integrator. The diagram shows the Model 610B acting as a current integrator. A square wave from a current source, I_x , is applied to the Model 610B input. Using the COULOMBS ranges, the output through the unity-gain terminals is shown.

b. Potentiometric Voltage Measurements. The high input impedance, 1-millivolt sensitivity and low zero drift make the Model 610B useful as a potentiometer. The circuit shown in Figure 11 is useful when no loading of the source voltage, on or off null, can be tolerated. Make the measurements with the center zero scale, following the procedures in paragraph 2-5. When the Model 610B is at null — no meter deflection — the voltage from the known source equals the unknown voltage.

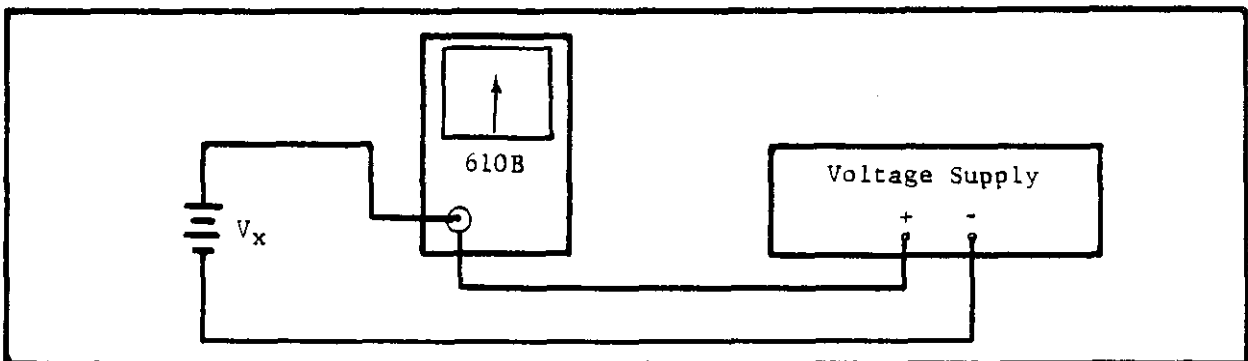

FIGURE 11. Potentiometric Voltage Measurements. An accurate voltage supply is used to buck out the potential from the unknown source, V_x . The Model 610B on the voltage ranges and center-zero scales acts as a null detector.

c. Measuring Diode Characteristics. The Model 610B can accurately measure diode characteristics in one simple step without using any other equipment. The circuit is shown in Figure 12. The measurements are made on the Model 610B OHMS ranges, selecting constant currents down to 10^{-11} ampere in decade steps and reading the voltage drop across the diode. The characteristic curve can then be plotted in volts and amperes or volts and ohms. Read the voltage from the meter.

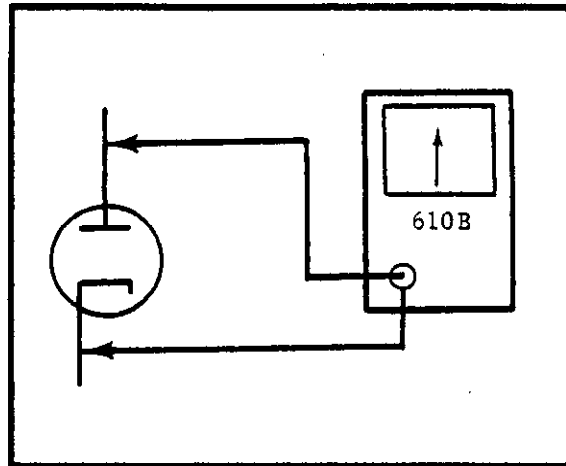

FIGURE 12. Measuring Diode Characteristics with Model 610B. Use the OHMS ranges of the Electrometer.

d. Peak-Reading Voltmeter. The Model 610B easily converts to a peak-reading voltmeter. Set the Range Switch to the COULOMBS ranges and apply the input voltage to the INPUT Receptacle through an external diode. In the circuit shown in Figure 13, if the input resistance (R_i) and diode leakage resistance (R_d) are high and if the time constant of the RC combination is high compared to the period of the signal, the capacitor will charge to the peak value of the applied ac voltage minus the small drop across the diode. The Model 610B input resistance on the VOLTS or COULOMBS ranges is 10^{14} ohms or greater, and may therefore be neglected compared to the leakage resistance of most diodes. The capacitor (C) is selected using the COULOMBS ranges with the FEEDBACK Switch in the NORMAL position. C in farads is equal to the COULOMBS range setting.

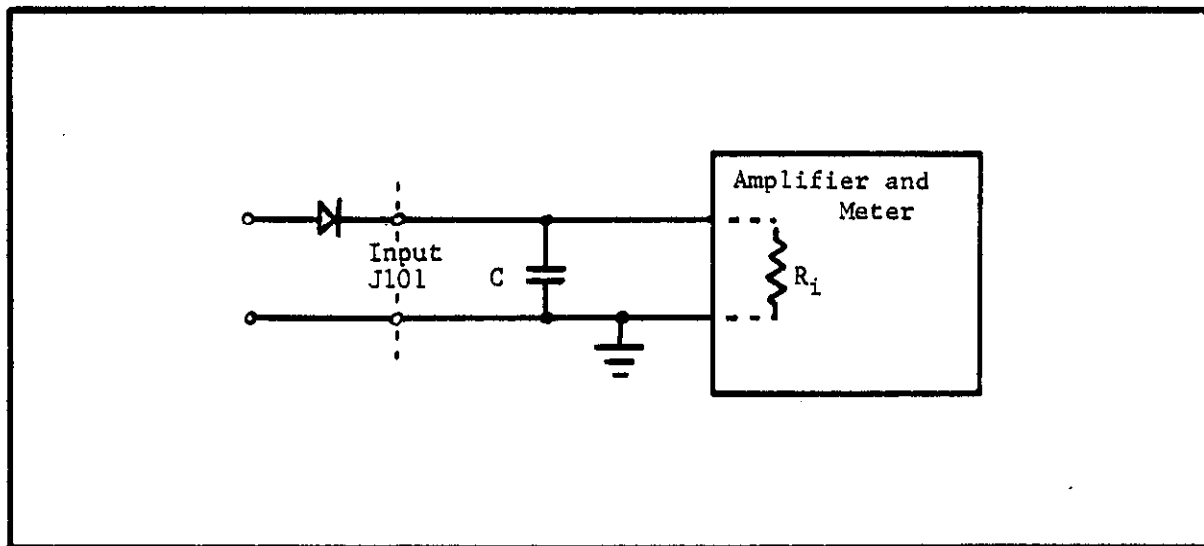

FIGURE 13. Diagram of Model 610B as Peak-Reading Voltmeter. The Model 610B is used on its COULOMBS ranges. The diode is external to the voltmeter. C is the capacitor selected with the Range Switch; R_i is the Model 610B input resistance. Accuracy of the measurements depends mainly upon the quality of the diode used.

SECTION 3. CIRCUIT DESCRIPTION

3-1. GENERAL.

a. The Keithley Model 610B is basically an extremely stable linear dc voltmeter with a full-scale sensitivity of 1 millivolt and an input impedance of 10^{14} ohms shunted by 22 picofarads. By using the front panel controls, shunt resistors and capacitors are selected to make measurements over a total of 79 voltage, current, resistance and coulomb ranges. Current and resistance are measured using precision resistance standards, from 10-ohm wirewound resistors to 10^{11} ohm glass-sealed, deposited carbon resistors. Coulombs are measured using close tolerance polystyrene film capacitor standards.

b. A super-regulated, low voltage transistorized power supply furnishes the necessary amplifier power.

3-2. VOLTMETER OPERATION.

a. The voltmeter amplifier has matched electrometer input tubes followed by three differential transistor stages and a vacuum tube output stage. A large amount of negative feedback is used for stability and accuracy. Figure 14 shows the block diagram for the voltmeter mode of operation.

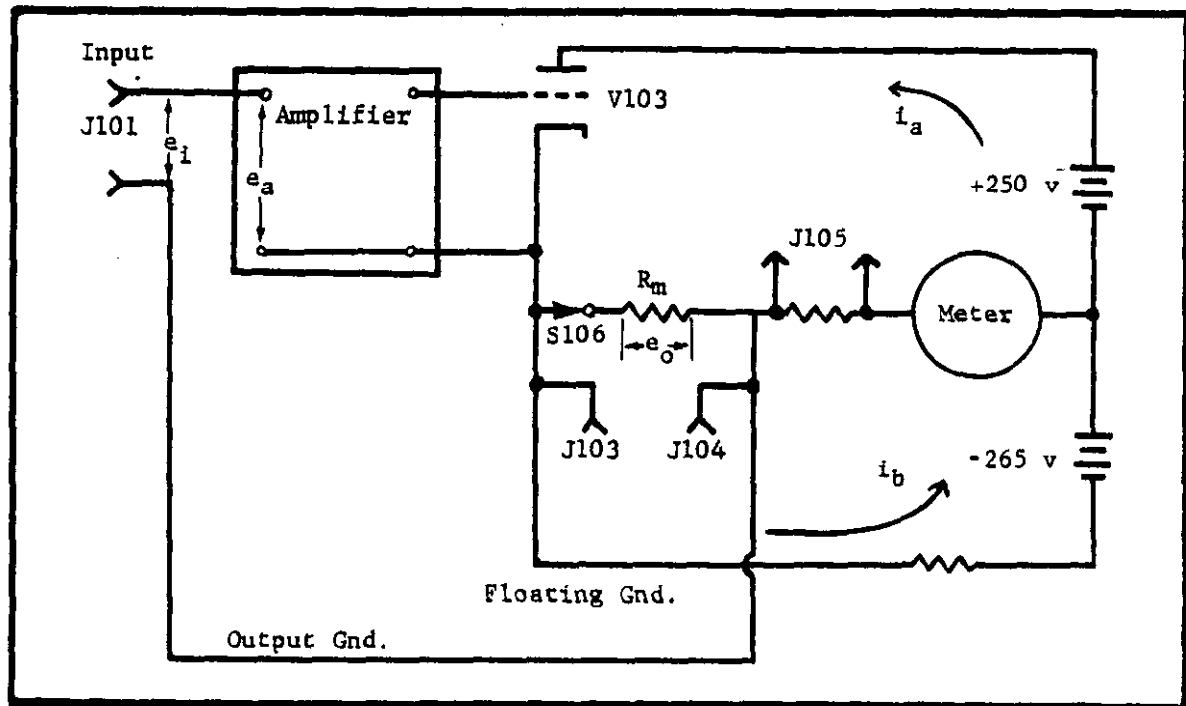

FIGURE 14. Block Diagram of Model 610B in Voltmeter Mode. Circuit designations refer to schematic diagram. e_i is the input voltage; e_a is the voltage drop across the amplifier. S106 is the Multiplier Switch; R_m is the resistor for a given Multiplier Switch setting. e_o is the voltage drop across R_m . J103 is the unity-gain terminal; J104, guard. i_a and i_b are instantaneous currents within the loops. Ground references correspond to schematic also.

b. When there is no input signal and the zero is set, the current (i_a) in the upper loop of Figure 14 equals that in the lower loop (i_b): $i_a = i_b$. With an input signal, the circuit reacts as follows:

1. When a positive voltage, $+e_i$, is applied to the input, the amplifier drives the V103 grid less negative, and the plate current, i_a , is increased. Increasing i_a causes a voltage drop through the Multiplier Switch resistor, R_m . At equilibrium this drop equals e_i , and therefore, it keeps the voltage drop, e_a , across the amplifier to a fraction of the input voltage.

2. When a negative voltage, $-e_i$, is applied to the input, the amplifier drives the V103 grid more negative with respect to the cathode, and i_a is decreased. The current in the lower loop, i_b , becomes greater than i_a , producing a voltage drop, e_o , across R_m . The drop is sufficient to null the negative input voltage, e_i , again keeping the voltage drop across the amplifier to a fraction of the input voltage.

3. The voltage drop across the amplifier is

$$e_a = \frac{e_i}{k + 1}$$

where k is the loop gain, approximately 10^5 on the 0.001 to 0.3-volt ranges.

c. The output stage, V103, drives the amplifier ground at the same potential as the input signal. This means the ground terminal of the amplifier is not at chassis ground, but is connected directly to the cathode of V103. Using this circuit, the input can accept voltages up to ± 100 volts without input dividers. This maintains high input impedance and eliminates instabilities which can occur with high resistance dividers.

NOTE

On the schematic diagram, amplifier ground is called "floating ground" and the output amplifier ground, "output ground."

d. All power supplies are floating with respect to the input or chassis ground. The +250 and -265 volt supplies are provided for the output voltage amplifier, V103. Separate regulated -10 and +21 volt supplies provide power for the amplifier and are referred to floating ground.

NOTE

Refer to Schematic Diagram 17795E for circuit designations.

3-3. VOLTMETER CIRCUIT.

a. Two balanced 5886 electrometer tubes are at the voltmeter amplifier input. Their filaments are operated in parallel from the regulated +21 volt supply through dropping resistors, R119 and R122. Resistors R101 and R113 protect the control grid of V101, the active electrometer tube, from excessive grid currents due to overloads. Capacitors C101 and C110 are high-frequency bypasses. The control grid of V102 is returned to floating ground.

b. Depressing the ZERO CHECK Button, S103, connects resistors R101 and R113 to output ground. This effectively removes all signal from the grid of V101, and the input impedance is reduced to 10 megohms.

c. An emitter follower stage, transistors Q101 and Q102, matches the relatively high impedance output of the electrometer tube stage to the low input impedance of the differential amplifier stage formed by transistors Q103 and Q104. This latter stage drives a second differential amplifier stage, transistors Q105 and Q106. Resistors R152 and R153 prevent lock-up of the amplifier under overload conditions.

d. Transistor Q106 drives the grid of the output voltage amplifier, V103. Resistor R184 protects V103 from drawing excessive grid current; capacitor C113 is a high-frequency bypass.

e. The zero balance controls adjust the dc voltages of the electrometer tube screen grids. The screen grids of V101 and V102 are returned, in effect, to the emitters of transistors Q103 and Q104 through the COARSE and MEDIUM ZERO Switches, S104 and S105. The emitter voltage of Q103 and Q104 can vary, resulting in a negative feedback loop for signals in phase at the electrometer tubes through the Q103 and Q104 emitter circuit back to the V101 and V102 screen grids. This connection stabilizes the electrometer plate potential and tube operating points. Also, for signals arriving at the V101 control grid, the first stage gain will be much greater than spurious signals.

f. The voltage drop across the Multiplier Switch resistors, R156 through R166, determines the voltmeter sensitivity. A 1.1-milliamper current through the resistors produces a full-scale meter deflection. On the higher voltage ranges, resistors R171 through R173 are across the collectors of Q103 and Q104 to reduce the amplifier gain. This assures the amplifier stability when maximum gain is unnecessary.

g. The recorder output is derived from the current flow from V103 through the Multiplier Switch resistor. With the Output Switch, S108, on 3V, ± 3 volts for full-scale deflection are obtained at the output connector, J105, by ± 1.1 milliamperes flowing through resistor R180. With S108 at 1 MA, resistors R174 and R179 are connected across J105, allowing ± 1 milliampere $\pm 5\%$ to pass through an external load.

h. The second triode section of V103, connected as a diode, provides warm-up compensation for the -265 volt supply. This prevents severe out-of-balance conditions during warm-up and cool-down, which could cause excessive electrometer tube grid current to flow and result in poor drift characteristics.

NOTE

The "normal" and "fast" referred to below are only the positions of the FEEDBACK Switch. "Normal method" is when the Switch is set to NORMAL; "fast method" is when the Switch is set to FAST.

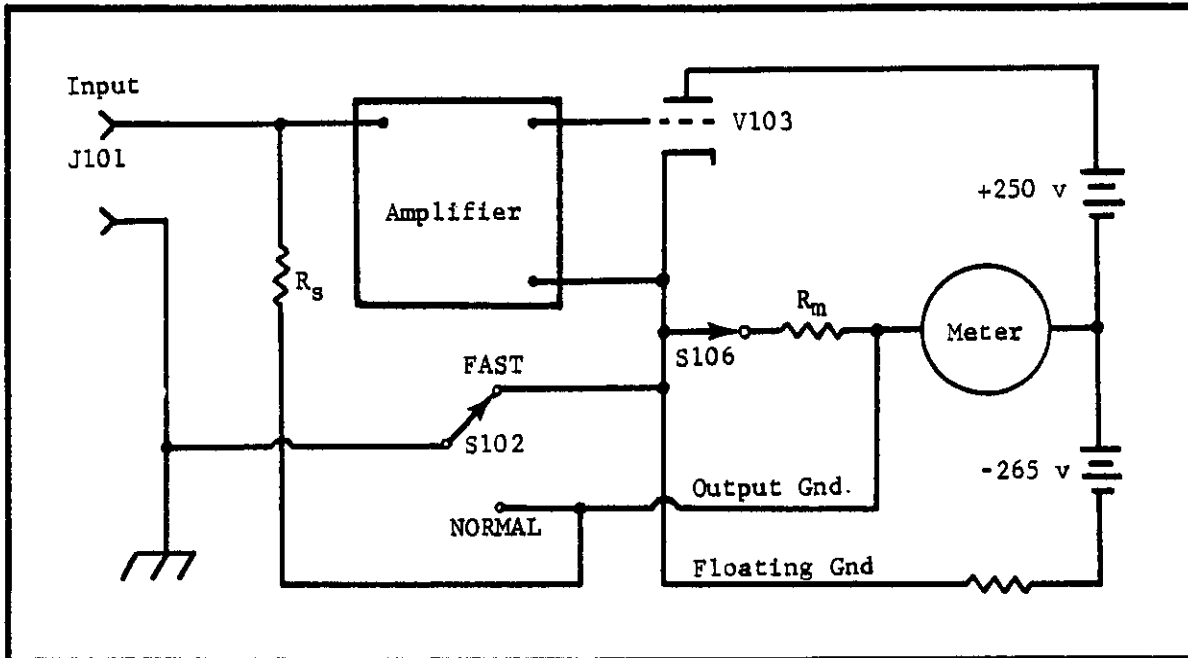

FIGURE 15. Block Diagram of Model 610B as a Picoammeter. Circuit designations refer to schematic diagram. S106 is the Multiplier Switch; R_m is the resistor for a given setting. R_s is the resistor selected by the Range Switch, S101. S102 is the FEEDBACK Switch. Ground references correspond to schematic.

3-4. AMMETER OPERATION.

a. Normal Method. In the normal method of current measurements (FEEDBACK Switch in NORMAL position), one of the Range Switch resistors, R102 through R112, shunts the input. (See Figure 15.) The Model 610B then measures the voltage drop across the resistor. The meter is calibrated to read the current in amperes for the appropriate range.

b. Fast Method. In the fast method of current measurements (FEEDBACK Switch in FAST position), the Model 610B functions as an ammeter with negative feedback. The differential amplifier output is divided by the Multiplier Switch resistors, R156 to R166, and fed back to the amplifier input through a feedback resistor selected with the Range Switch. (See Figure 15.) Floating ground is connected to the low impedance side of the input, and the output ground is floating. This method increases the response speed by minimizing the effects of input capacity; it also reduces the input drop to less than 1 millivolt.

3-5. OHMMETER OPERATION.

a. Normal Method. In the normal method of resistance measurements (FEEDBACK Switch in NORMAL position), the Model 610B uses a constant-current, voltage-drop circuit. Refer to Figure 16. R_x is the unknown resistor. A voltage source, E , applies a potential across R_x . The source is obtained from the +21 volt supply through the resistor divider network, R114 through R118. E varies from 0.1 to 10 volts, depending upon the OHMS range used. The voltage source is connected between floating ground and the input grid of V103 through R_s , the range resistor. R_s is one of the resistors, R102 through R112. Since feedback to the

floating ground keeps the grid at nearly the same potential as the cathode, the current, I , through R_x and R_s is constant. I is equal to E/R_s , regardless of the value of R_x , as long as the voltage drop across R_x does not exceed the Multiplier Switch setting. This circuit provides a true source regardless of the input. The Model 610B can then measure the voltage drop across R_x and indicate the resistance value on its calibrated meter.

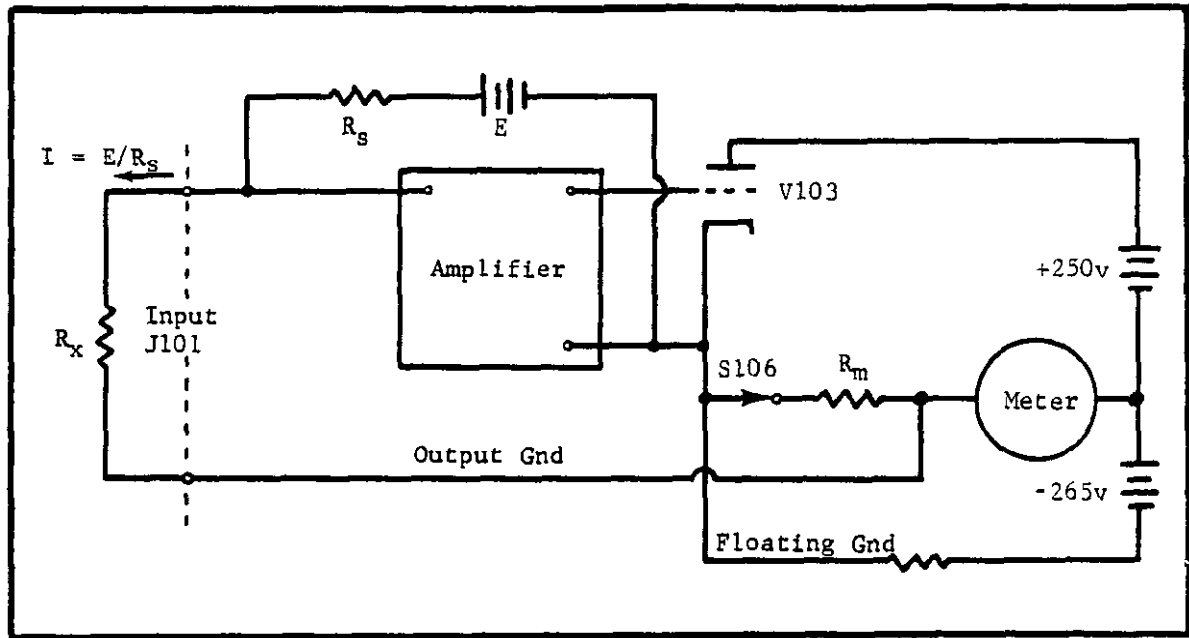

FIGURE 16. Block Diagram of Model 610B for Normal Method of Measuring Resistance. Circuit designations refer to schematic diagram. S106 is the Multiplier Switch; R_m is the resistor for a given setting. R_x is the unknown resistance being measured; E is the voltage source (see paragraph 3-5); R_s is the range resistor selected with the Range Switch. Ground references correspond to the schematic.

b. Guarded Method. In the guarded method of resistance measurements (FEED-BACK Switch in FAST position and the sample resistance connected between the input terminal, J101, and the guard terminal, J104), feedback is applied through the sample. Refer to Figure 17. The circuit is similar to the normal method, except for the feedback. This reduces the slowing effect of the instrument's input capacity. Leakage error is also reduced since the potential across the input terminal is small. In this mode, floating ground is connected to the low impedance side of the input and the output ground is floating. The guard terminal is at output ground potential.

3-6. COULOMBMETER OPERATION. The Model 610B circuit for measuring charge is similar to that used for an ammeter with the fast method. A negative feedback is applied around a shunt capacitor, C103 to C106, selected with the Range Switch. The shunt capacitor replaces R_s in Figure 15. The stored charge is proportional to the voltage across the capacitor, which is measured by the Model 610B voltmeter circuits.

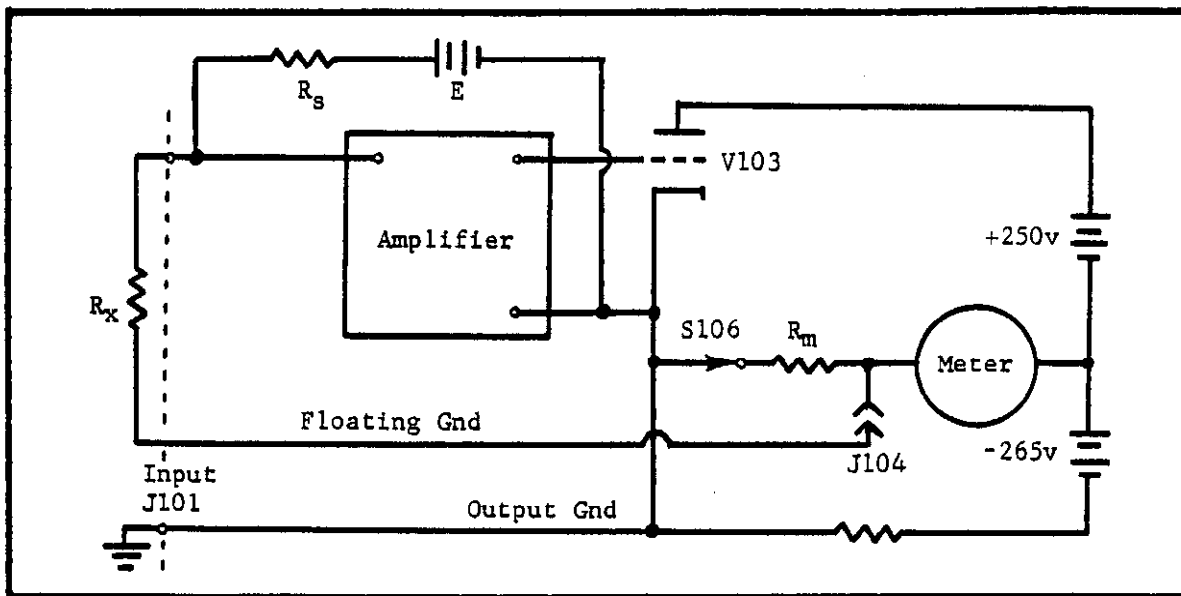

FIGURE 17. Block Diagram of Model 610B for Guarded Method of Measuring Resistance. Circuit designations refer to schematic diagram. S106 is the Multiplier Switch; R_m is the resistor for a given setting. R_x is the unknown resistor being measured; E is the voltage source (see paragraph 3-5); R_s is the range resistor selected with the Range Switch. J104 is the GUARD terminal. Ground references correspond to the schematic.

3-7. POWER SUPPLY. The power supply operates from the line voltage and furnishes +250, -265, +21 and -10 volts to the differential amplifier.

a. A 24-volt rms output from the power transformer, T201, is full-wave rectified by diodes D203 and D204 and is filtered by capacitor C204. The dc voltage across C204 is approximately 30 volts dc.

b. To obtain a stable, accurate voltage, the output of the series transistor, Q202, is regulated by comparing a sample voltage from dividers R212 and R214 to the zener diode reference, D210. If a voltage difference exists, it is amplified by a differential amplifier consisting of transistors Q204 and Q205. The signal is further amplified by transistor Q203. The output of Q203 is applied to Q202 to nullify input and load variations. Capacitor C208 prevents high-frequency oscillations. The +21 volts at the output of the regulator powers the amplifier, the filament of the electrometers, and is used as the reference supply for the OHMS ranges.

c. Transistor Q203 operates at a high gain by connecting its collector load to a negative regulated supply. The circuit permits linear operation of Q202 with widely varying input voltages. To supply Q203, a 50-volt output of transformer T201 is half-wave rectified by diode D201 and is filtered by capacitors C203 and C205. Resistor R201 is a dropping resistor. The voltage across the zener diode D202 is a stable -10 volts, which is supplied to resistor R209, the collector load resistor of Q203, and the differential amplifier.

d. Transistor Q201 is an emitter follower whose function is to increase the current gain of the series transistor, Q202, forming a Darlington pair. Resistors R208 and R209 and diode D208 provide current overload protection. Excessive current drawn from the power supply causes an increased voltage drop across R208, which forward biases diode D208, thus preventing the collector of Q203 from going more negative. Since the collector voltage cannot rise, further amplification is prevented and, therefore, further current increase is prevented.

e. The +250 volts and -265 volts for the output stage are obtained from a single winding on transformer T201. 210 volts from the transformer is half-wave rectified by diodes D205 and D206, and filtered by capacitors C206 and C207, respectively. Resistor R203 provides short-circuit protection; resistor R204 discharges the capacitors when the instrument is turned off.

SECTION 4. MAINTENANCE

4-1. GENERAL.

a. Section 4 contains the maintenance, troubleshooting and calibration procedures for the Model 610B Electrometer. It is recommended that these procedures be followed as closely as possible to maintain the accuracy of the instrument.

b. The Model 610B requires no periodic maintenance beyond the normal care required of high-quality electronic equipment. The value of the high-megohm resistors, R110, R111, R112, should be checked every two or three years for specified accuracy. Also, the dc amplifier balance requires occasional adjustment; see paragraph 4-8.

4-2. PARTS REPLACEMENT.

a. The Replaceable Parts List in Section 6 describes the electrical components of the Electrometer. Replace components only as necessary. Use only reliable replacements which meet the specifications.

b. The electrometer tubes, V101 and V102, are specially matched and aged; order only from Keithley Instruments, Inc. In normal use, they should not need replacement before 10,000 hours of operation. They can be checked only by replacement. Standard 5886 tubes could be used in an emergency, but the drift, noise and grid current specifications may not be met. When replacing the electrometer tubes with a matched set from Keithley, further ageing of the tubes within the Model 610B is required; a minimum of 3 days is recommended.

NOTE

When replacing the electrometer tubes, do not touch the glass base where the leads emerge. Increased leakage will result from any contamination.

c. Transistor pairs Q101, Q102 and Q103, Q104 are matched for dc current (h_{FE}). Order only from Keithley Instruments, Inc.; replace only as a pair.

4-3. TROUBLESHOOTING.

a. The procedures which follow give instructions for repairing troubles which might occur in the Model 610B. Use the procedures outlined and use only specified replacement parts. Table 1 lists equipment recommended for troubleshooting. If the trouble cannot

Instrument	Use
dc voltmeter, with minimum 100-megohm input resistance, 10% accuracy, range from one volt to 300 volts.	Circuit checking
Tektronic Type 561A Oscilloscope	Observe wave forms in power supply

TABLE 1. Equipment Recommended for Model 610B Troubleshooting. Use these instruments or their equivalents.

Difficulty	Probable Cause	Solution
Excessive zero drift.	Electrometer tubes may be defective.	Check V101 and V102; replace if faulty.
	Dc amplifier not balanced.	Check per paragraph 4-8.
Excessive grid current.	Excessive humidity or defective electrometer tube.	Check V101 and V102; replace if faulty.
Excessive microphonics.	Defective electrometer tube.	Check V101 and V102; replace if faulty.
Cannot meter zero on any range.	See paragraph 4-4.	See paragraph 4-4.
Meter will not zero on Multiplier Switch setting.	Faulty resistor for setting of Multiplier Switch.	Check resistors; replace if faulty.
10^{-10} to 10^{-14} ampere current ranges are out of specifications.	Defective high megohm resistors.	Check per paragraph 4-9.

TABLE 2. Model 610B Troubleshooting. See paragraph 4-2 for checking V101 and V102.

be readily located or repaired, Keithley Instruments, Inc., can service the instrument at its complete service facilities. Contact your nearest representative.

b. Table 2 contains the more common troubles which might occur. If the repairs indicated in the table do not clear up the trouble, find the difficulty through a circuit-by-circuit check, such as given in paragraph 4-4. Refer to the circuit description in Section 3 to find the more critical components and to determine their function in the circuit. The complete circuit schematic, 17795E, is found in Section 6.

4-4. PROCEDURES TO GUIDE TROUBLESHOOTING.

a. If the instrument will not operate, check the fuse, line cord and power source. If these are all found satisfactory, use the following procedures to isolate the trouble.

b. The schematic diagram indicates all tube element voltages and transistor terminal voltages referenced to floating or output ground; check Notes on the diagram. The control settings for these values are the Range Switch at VOLTS, Multiplier Switch at 1, and the meter zeroed. Measurements are with a 100-megohm dc voltmeter.

c. At times, the meter will not zero on any range with the input shorted. Adjust the COARSE ZERO Switch, S104 (Figure 5), to bring the Model 610B into balance. If this does not work, continue to check the circuits.

1. Check the filaments of the electrometer tubes, V101 and V102, by measuring the voltage drop across the filament dropping resistor, R119 (Figure 22). If both filaments are operating properly, the voltage will read 2.0 volts dc $\pm 10\%$.

2. Check the output tube, V103 (Figure 23), to see that both filaments are lit.

3. Inspect the leads from the shock-mounted input printed circuit board, PC-84, to the amplifier printed circuit board, PC-85, for possible breaks.

d. Power Supply.

1. Set the FEEDBACK Switch to FAST to connect the instrument's chassis to floating ground. Connect a 100-megohm dc voltmeter between the -10 volt supply and the chassis. (-10 V is indicated on PC-86, Figure 18.) The voltage should be -10 volts dc $\pm 20\%$.

2. Connect the voltmeter between the +21 volt supply and the chassis. (+21 V is indicated on PC-86, Figure 18.) The +21 volt supply can not operate unless the -10 volt supply is operating. The voltage should be +21 volts dc $\pm 10\%$. A faulty +21 volt supply can indicate a faulty zener, D210 (Figure 23).

3. Check the +250 and -265 volt supplies; these should be correct within 10%. For this measurement, use output ground as the common connection for both supplies.

e. Amplifier.

1. To check the amplifier, disconnect the feedback loop by removing the output tube, V103. This allows each stage of the amplifier to be individually checked. It also eliminates the possibility of applying excessive voltage to the electrometer tube grids, causing serious damage.

NOTE

Use a 100-megohm dc voltmeter as a null detector to check the amplifier stages. Do not ground its low side.

2. Connect the voltmeter between the plates of V101 and V102 (Figure 22). Adjust the COARSE and MEDIUM ZERO Controls for null. If a null cannot be reached, check V101, V102, the COARSE and MEDIUM ZERO Control circuits (resistors R128 to R151), and transistors Q101 and Q102. Check the transistors by removing them and adjusting for null again. If null is now reached, replace the transistor pair with a new pair.

3. Check the next stage by connecting the voltmeter across the emitters of Q101 and Q102 (Figure 21) and adjusting the COARSE and MEDIUM ZERO Controls for null. If a null is not reached, check this stage and the base circuit of the next stage. Check the base circuit by removing transistors Q103 and Q104 and again adjust for null. If null is now reached, replace the transistor pair with a new pair.

4. Check the next stage by connecting the voltmeter across the collectors of Q103 and Q104 (Figure 21), and adjusting the COARSE and MEDIUM ZERO Controls for null. If a null is not reached, check this stage and for shorts in the base circuit of Q105 and Q106.

5. Connect the voltmeter across the collectors of Q105 and Q106. Adjust the FINE ZERO Control for null. If null is reached, the dc amplifier is operating correctly and the trouble is in the output stage or the feedback stage.

6. Check the output stage cathode resistor, R185 (Figure 24), and capacitor, C113 (Figure 23), for a possible short.

7. The feedback loop includes the multiplier resistors, R156 through R166, the recorder output resistors, R180 on 3V position or R174 and R179 on 1 MA position, and the meter. An opening of any of these components prevents zeroing of the meter. An open multiplier resistor, however, prevents zeroing for only that particular multiplier setting.

4-5. 234-VOLT OPERATION. The Model 610B is shipped for use with a 117-volt power source unless otherwise ordered. To convert it for 234-volt sources, use a screwdriver to change the slide switch on the back panel to 234. Change the fuse from 1/4 ampere to 1/8 ampere. No other adjustment is necessary. To switch from 234 to 117-volt operation, reverse the procedures.

4-6. CALIBRATION PROCEDURES.

a. The following procedures are recommended for calibrating and adjusting the Model 610B. Use the equipment recommended in Table 3. If proper facilities are not available or if difficulty is encountered, contact Keithley Instruments, Inc., or its representatives to arrange for factory calibration.

b. Procedures are covered for the following: grid current check, dc amplifier balance adjustment, high-megohm resistor verification, calibration of the ohms ranges, meter zero calibration and accuracy check.

1. Check grid current (paragraph 4-7) at regular intervals to make sure the electrometer tubes are functioning correctly.

Instrument	Use
Keithley Instruments Model 241 Regulated High Voltage Supply	Calibrate meter zero and verify voltage range accuracy.
Keithley Instruments Model 261 Picoampere source, from 10^{-14} to 10^{-4} ampere, $\pm 0.25\%$ to $\pm 1.5\%$.	Calibrate current, resistance and charge ranges.
Keithley Instruments Model 370 Recorder	Zero drift check.
Keithley Instruments Model 515 Megohm Bridge	Verify high-megohm resistors in Range Switch.
Keithley Instruments Model 662 Guarded Differential Voltmeter	Calibrate resistance ranges and meter zero.

TABLE 3. Equipment Recommended for Model 610B Calibration. Use these instruments or their equivalents.

Control	Circuit Designation	Fig. Ref.	Refer to Paragraph
Ohms Calibration	R115	18	4-10
Meter Center Zero Calibration	R167	18	4-11
Meter Calibration	R175	18	4-11
DC Amplifier Balance	R177	19	4-8

TABLE 4. Model 610B Internal Controls. The Table lists all internal controls, the figure picturing the location and the paragraph describing the adjustment.

2. The dc amplifier balance adjustment (paragraph 4-8) is necessary about every six months or when amplifier components are replaced.

3. Verify the value of the high-megohm resistors (paragraph 4-9) about every six months to check on drifting.

4. Calibrate the ohms ranges (paragraph 4-10) about once a year or when range resistor or power supply components are replaced.

5. Calibrate the meter zero (paragraph 4-11) about once a year or when components are replaced.

6. Check the Model 610B (paragraph 4-12) once a year, after the other adjustments, or if improper operation is suspected.

c. If the Model 610B is not within specifications after the calibrations and adjustments, follow the troubleshooting procedures or contact Keithley Instruments, Inc., or its nearest representative.

4-7. GRID CURRENT CHECK. Check grid current whenever excessive noise or drift is suspected. To read the grid current of the Model 610B, set the front panel controls to:

METER Switch	+
Multiplier Switch	.01
Range Switch	10 ⁻¹¹ AMPERES
ZERO CHECK Button	Unlocked
FEEDBACK Switch	FAST

Cap the INPUT Receptacle. The grid current indicated on the meter should be less than 2×10^{-14} ampere. If this is exceeded, check the +21 volt supply and the electrometer Tube, V101.

4-8. DC AMPLIFIER BALANCE ADJUSTMENT. Gradual aging of components may require an occasional adjustment of the amplifier balance. Also adjust if amplifier components are replaced. This adjustment sets the gain to allow the meter to receive the correct signal on all ranges.

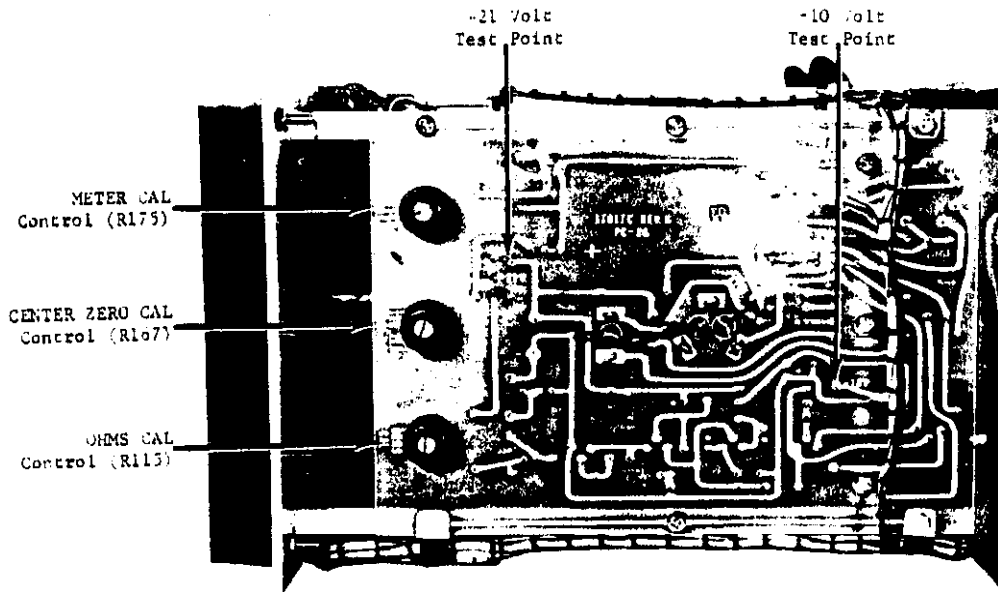

FIGURE 18. Model 610B Internal Controls. Test points for the -10 volt and +21 volt power supplies are also shown. Refer to Figure 19 for the DC AMP BAL Control.

a. Set the front panel controls to:

METER Switch	CENTER ZERO
Multiplier Switch	0.1
Range Switch	VOLTS
ZERO CHECK Button	LOCK
FEEDBACK Switch	NORMAL

Zero the meter on the 0.1-volt range.

b. Connect the floating Model 662 across the collectors of transistors Q105 and Q106 (this is across the ends of resistors R181 and R182, Figure 21). Make the connections from the component side of the printed circuit board. Float the Model 662 ground terminal.

c. Adjust the DC AMP BAL potentiometer, R177 (Figure 19), until the meter shows a null.

4-9. HIGH-MEGOHM RESISTOR VERIFICATION.

a. About every six months, it is necessary to check the value of the high-megohm resistors, R110 to R112, on the Range Switch. The instrument should be within its rated accuracy for two or three years from the time it leaves the factory. After this, some of the resistors may drift out of tolerance and should be replaced. Faulty high-megohm resistors will affect the accuracies of measurements for the 10^{-9} to 10^{-11} AMPERES and the 10^8 to 10^{12} OHMS settings of the Range Switch.

b. To check these resistors, it is necessary to use a bridge capable of better than 1% accuracy up to 10^{11} ohms. An accurate megohm bridge, such as the Keithley Instruments Model 515 Megohm Bridge which is accurate to 0.25% for these ranges, is therefore necessary. If such equipment is not available, two procedures are recommended to check out the resistors:

1. Return the complete instrument to the factory for resistor calibration.
2. Replace the high-megohm resistors periodically with a certified set from Keithley Instruments to assure absolute calibration accuracy.

4-10. CALIBRATION OF OHMS RANGES. This calibration adjusts the constant power supply needed for resistance measurements. It must be accurate to maintain specified resistance measurement accuracy.

a. Connect the Model 662 to the junction of resistors R115 and R116 (Figure 24) and the common lead to the + terminal of capacitor C203 (Figure 23). Adjust the OHMS CAL potentiometer, R115 (Figure 18), for 10 volts dc $\pm 0.5\%$.

b. If the control does not have enough latitude, check the +21 volt supply (paragraph 4-4).

4-11. METER ZERO CALIBRATION. Check meter zero whenever components are replaced or other adjustments are made.

a. Turn the METER Switch to METER OFF. Set the mechanical Zero Meter adjustment for zero meter reading (top-scale zero).

b. Turn the Model 610B on. Zero the meter on the .001-volt range. Then switch to the 10-volt range. Set the Multiplier Switch to 10; apply 10 volts $\pm 0.05\%$ to the Model 610B INPUT Receptacle. Adjust the METER CAL potentiometer, R175 (Figure 18), for full-scale meter reading.

c. Set the center zero by first zeroing the meter on the .001-volt range. Then switch to the 1-volt range. Set the METER Switch to CENTER ZERO and adjust the CENTER ZERO CAL potentiometer, R167 (Figure 18), for exact center-scale meter zero.

4-12. ACCURACY CHECK.

a. Checking the accuracy is the quickest way to spot improper Electrometer operation. Perform the check about once a year, if components are replaced, or if other adjustments made. If accuracy is verified over all ranges, the Model 610B should be able to meet all specifications. If the accuracy must be checked often, check for zero drift.

b. Voltage. Connect the Model 610B to the Model 241 Power Supply. First, set the Model 610B for the 10-volt range. Increase the input voltage in 1-volt steps. The Model 610B should indicate the input voltage to $\pm 1\%$ of full scale. Check the other voltage ranges for accuracy at full scale.

c. Current. Connect the Model 610B to the Model 261 Picoampere Source. Check the full-scale accuracy of all current positions on the Range Switch. For the .1 to 10^{-4} ampere ranges, set the FEEDBACK Switch to NORMAL. For

the 10^{-5} to 10^{-11} ampere ranges, set the FEEDBACK Switch to FAST. The Model 610B should indicate the input current to $\pm 2\%$ of full scale from the $.1$ to 10^{-8} ampere ranges, $\pm 4\%$ of full scale from the 10^{-9} to 10^{-11} ampere ranges.

d. Ohms. All resistance ranges will be within specifications if the current ranges are within specifications and if the ohms range calibration (paragraph 4-10) is correct. No other procedures are necessary.

e. Coulombs. Set the FEEDBACK Switch to FAST and the Multiplier Switch to 3. Use the current source to provide an input current. With the Range Switch set to the COULOMBS ranges given in Table 5, apply the corresponding input current. Use a stop watch to time the rise to full-scale deflection.

COULOMBS Range (Range Switch)	Input Current To Model 610B	Minimum Rise Time (Zero to Full Scale)
10^{-7}	10^{-8} ampere	30 seconds
10^{-8}	10^{-9} ampere	30 seconds
10^{-9}	10^{-10} ampere	30 seconds
10^{-10}	10^{-11} ampere	30 seconds

TABLE 5. Coulomb Ranges Accuracy Check. The table gives the input current needed to check the rise time for each coulomb range.

4-13. DRIFT CHECK. Refer to the accuracy check before performing the drift check.

a. Set the front panel controls to

METER Switch	+
Multiplier Switch	.03
Range Switch	VOLTS
ZERO CHECK Button	LOCK
FEEDBACK Switch	NORMAL

Set the Output Switch on the back panel to 3 V.

b. Connect the Model 610B OUTPUT Receptacle to the Model 370 Recorder. Set the recorder to 1 volt. Make sure the Model 610B chassis cover is attached with at least two screws.

c. Make the drift run for at least 24 hours. The zero drift specification is 200 microvolts per hour maximum averaged over any 24-hour period after warm-up; during two-hour warm-up, no more than 2 millivolts after the first hour (Refer to Chart 1).

d. Change electrometer tubes if the instrument does not meet the zero drift specification.

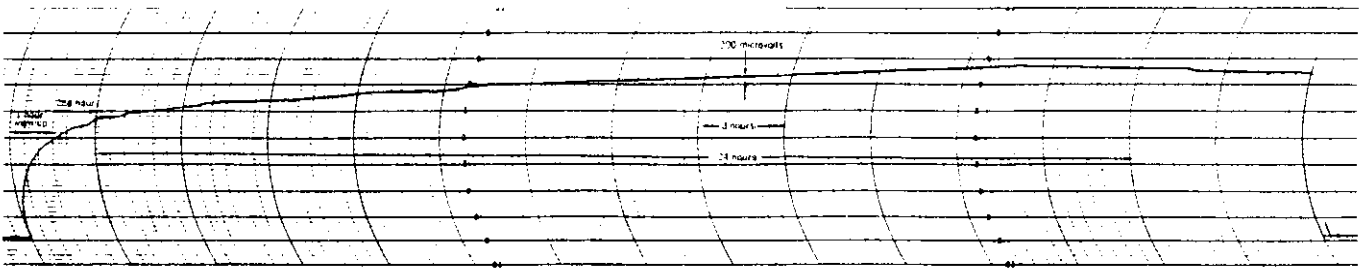

CHART 1. Typical drift run of Keithley Model 610B. The drift run shows the stability of the Electrometer. After 1-hour warm-up the drift is no more than 2 millivolts in the second hour. In any subsequent 24-hour period, the average drift will not exceed 200 microvolts per hour.

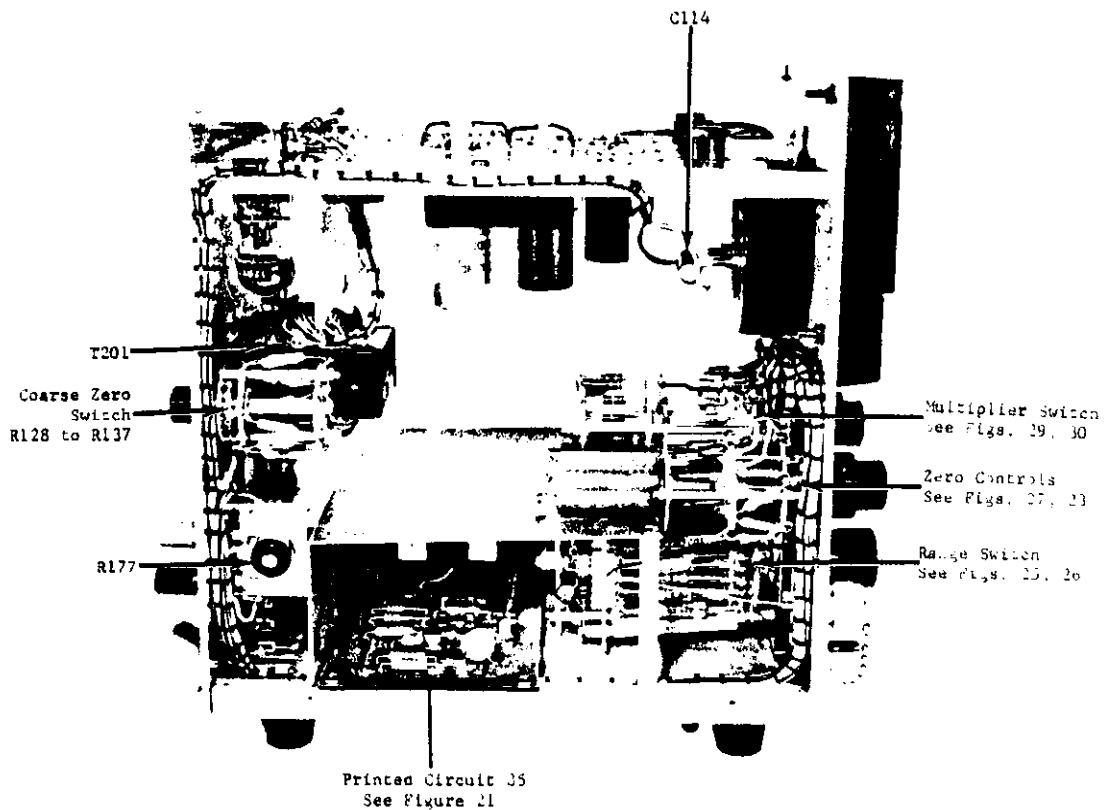

FIGURE 19. Side View of Model 610B Chassis. Front panel faces right. Location of components, printed circuits and switches is shown. Refer to the Parts List for circuit designations. Figure 20 shows the opposite side.

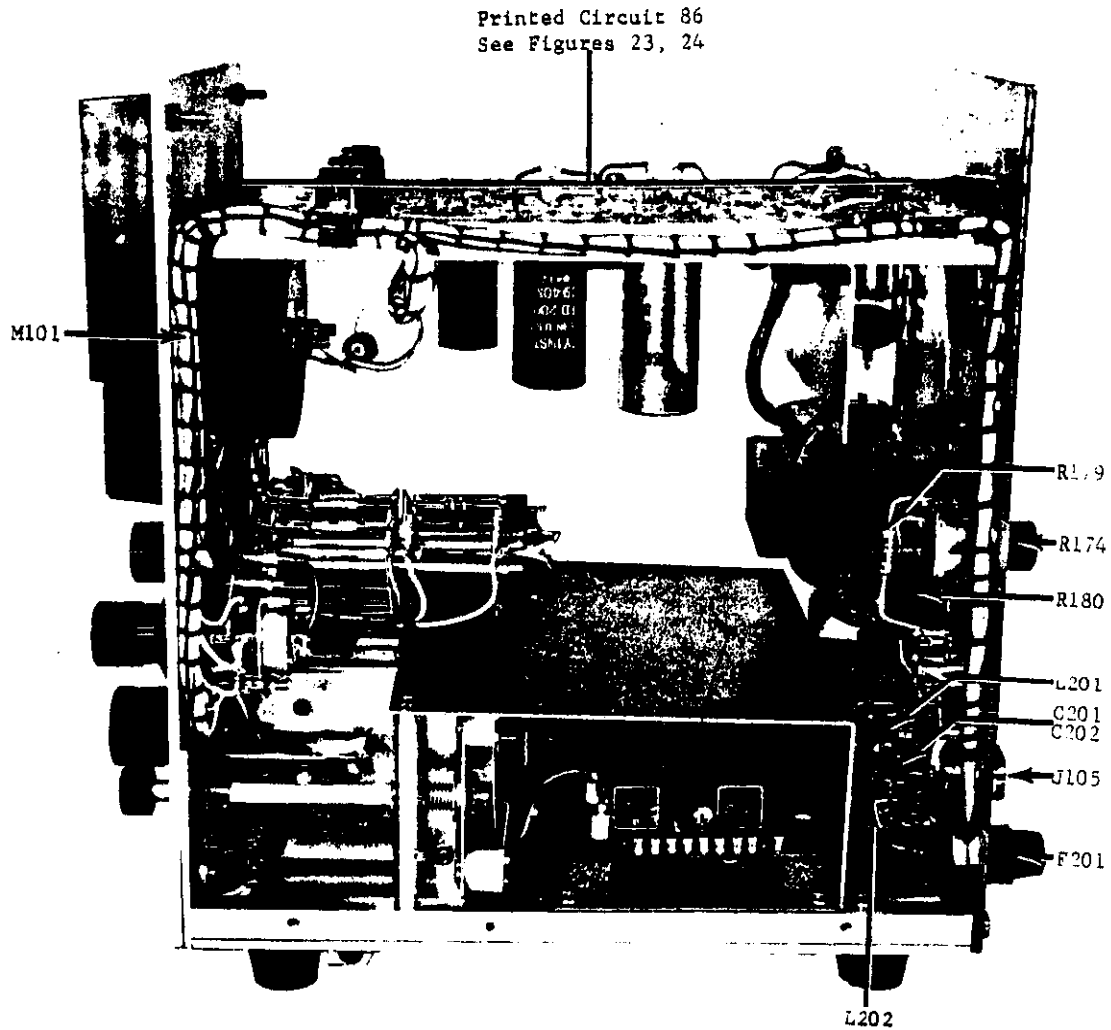

FIGURE 20. Side View of Model 610B Chassis. Front panel faces left. Location of components and printed circuits is shown. Refer to the Parts List for circuit designations. Figure 19 shows the opposite side.

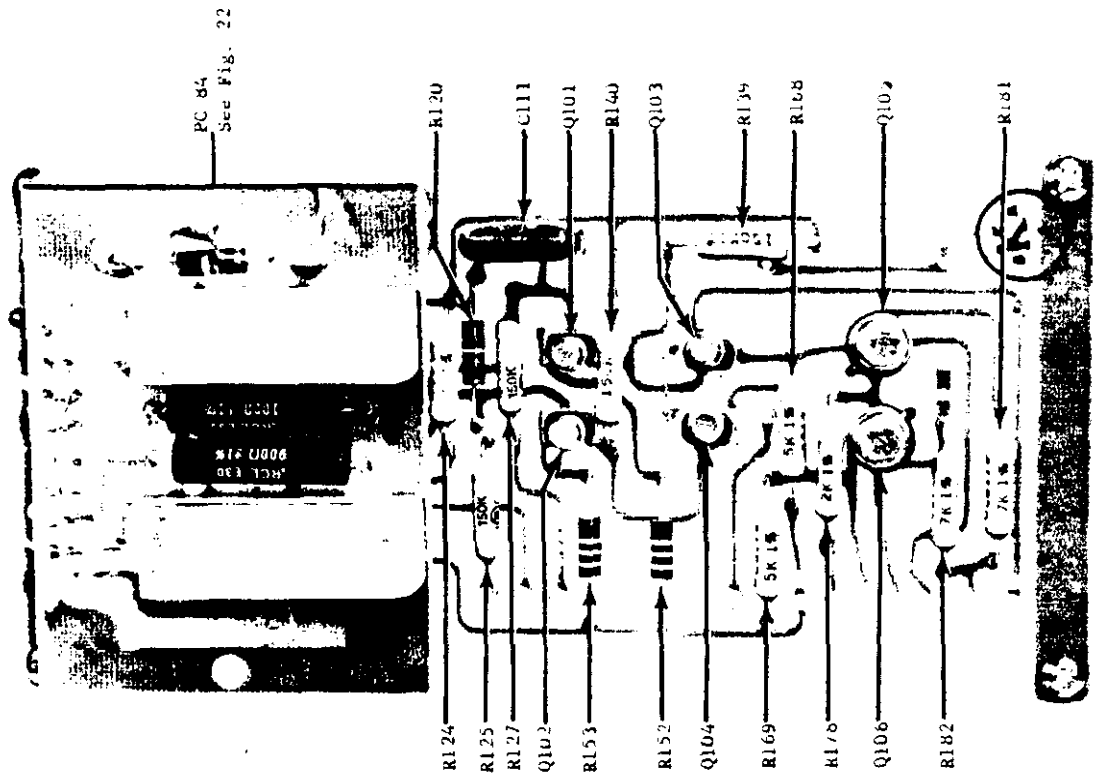

FIGURE 21. Component Locations on Printed Circuit 85.

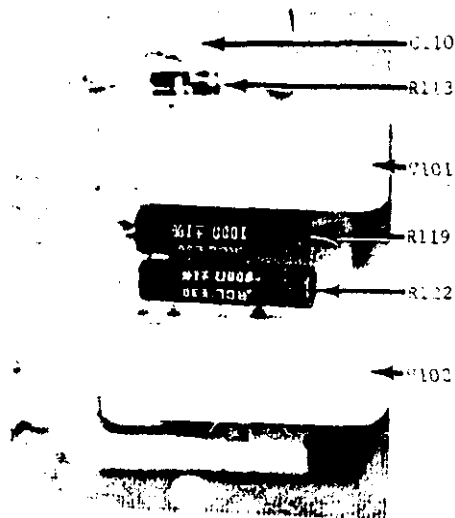

FIGURE 22 (left). Component Locations on Printed Circuit 84. The red dots on V101 and V102 are toward each other.

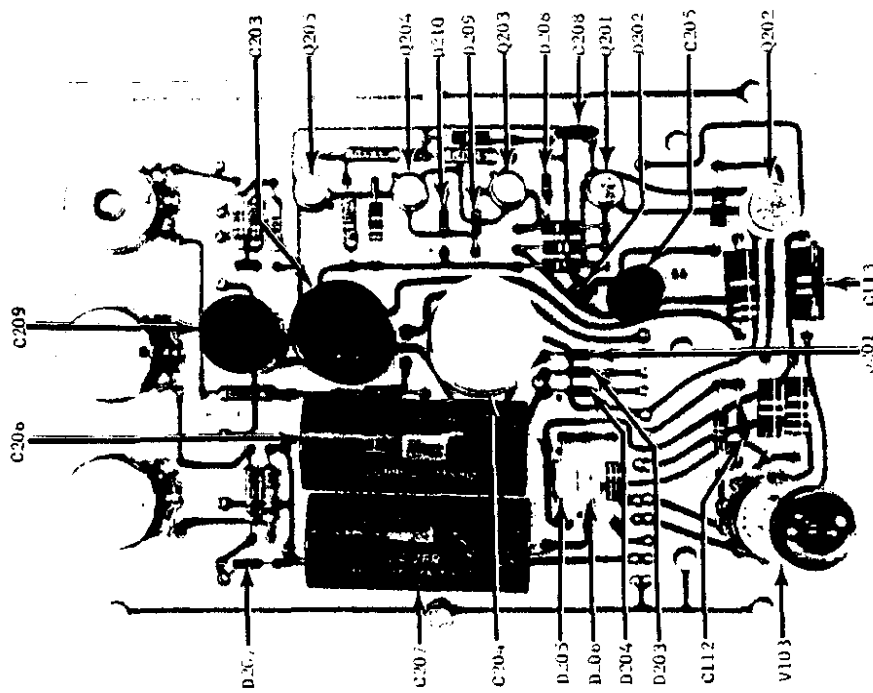

FIGURE 23. Capacitor, Diode, Transistor and Vacuum Tube Locations on Printed Circuit 86. Resistors are shown in Figure 24.

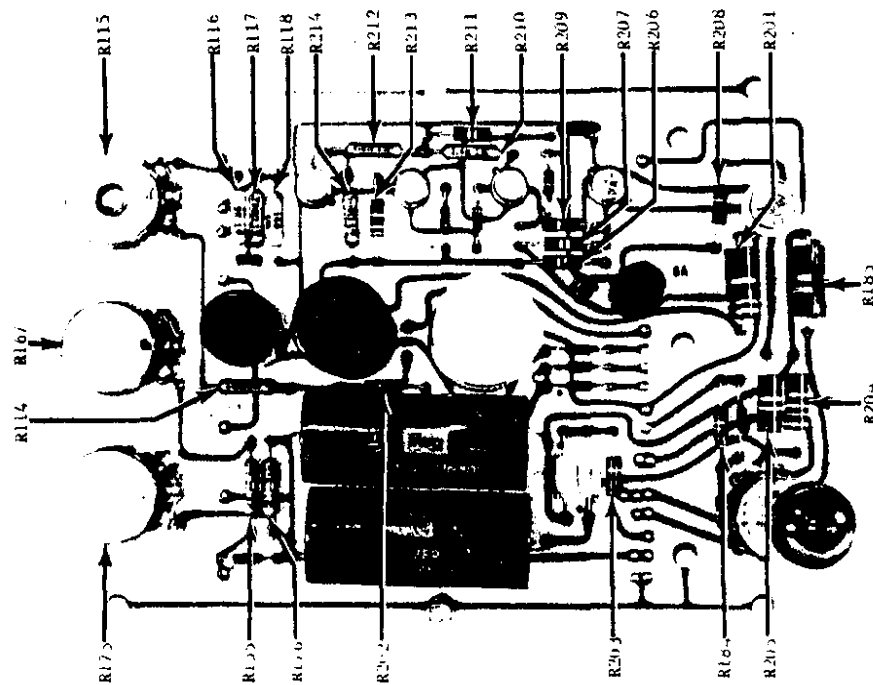

FIGURE 24. Resistor Locations on Printed Circuit 86. Other components are shown in Figure 23.

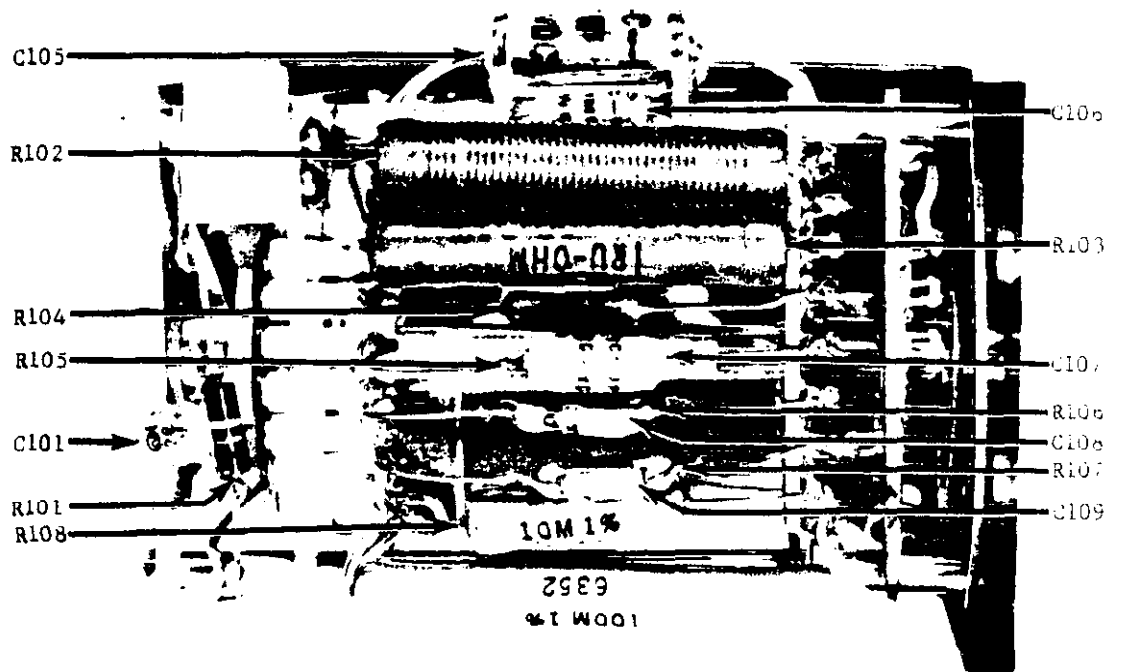

FIGURE 25. Component Locations on Range Switch, S101. Figure 26 shows the high-megohm resistors. Capacitors C103 and C104, not shown, are parallel to capacitors C105 and C106.

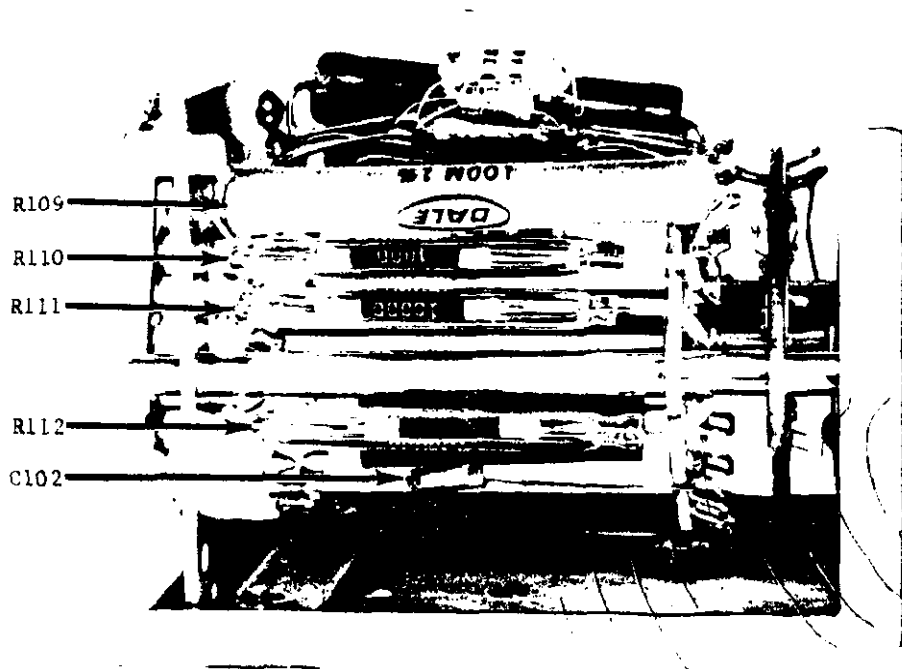

FIGURE 26. Component Locations on Range Switch, S101. Figure 25 shows the other components.

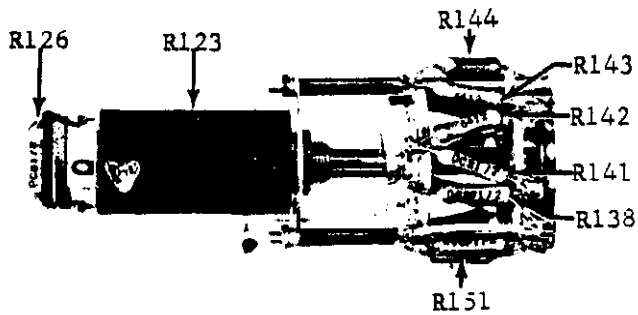

FIGURE 27. Component Locations of MEDIUM and FINE ZERO Controls. Also refer to Figure 28.

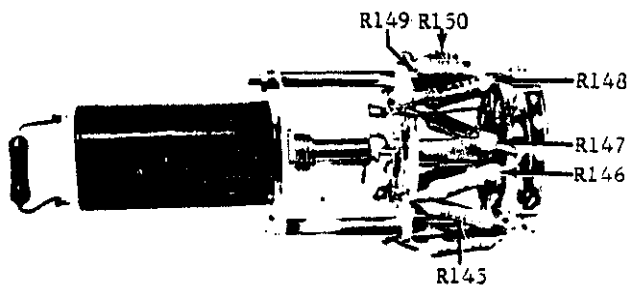

FIGURE 28. Component Locations of MEDIUM and FINE ZERO Controls. Also refer to Figure 27.

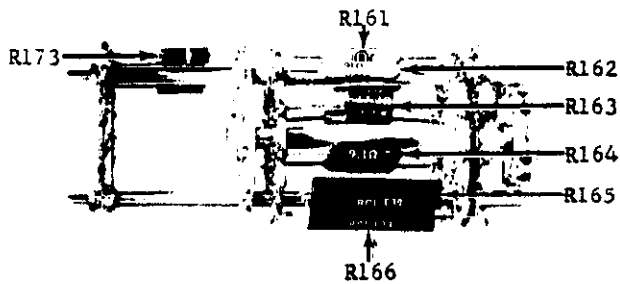

FIGURE 29. Component Locations of Multiplier Switch, S106. Also refer to Figure 30. Resistor R170, not shown, is parallel to resistor R166.

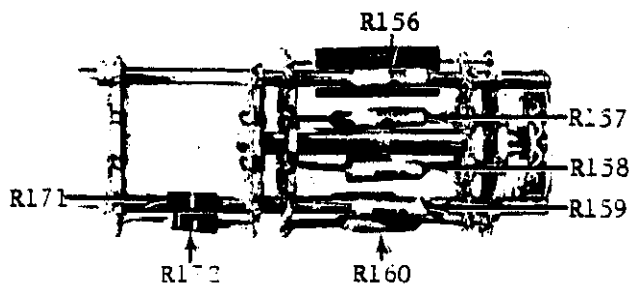

FIGURE 30. Component Locations of Multiplier Switch, S106. Also refer to Figure 29.

SECTION 5. ACCESSORIES

5-1. MODEL 6101A SHIELDED TEST LEAD.

a. The Model 6101A is a probe and shielded lead to make measurements with the Model 610B more convenient. It does not alter any Model 610B specification. The Lead is furnished with 30 inches of low-noise cable terminated by a uhf-type plug. The plug connects directly into the Model 610B INPUT Receptacle.

b. Using the Model 6101A Lead insures better input connections (see paragraph 2-3). Its operation with the Model 610B is explained in paragraph 2-5.

5-2. MODEL 6101B GRIPPING PROBE. The Model 6101B is a gripping probe to permit fast, easy measurements. The gripping feature is useful for attaching the probe at a single point for repeated measurements. It is furnished with a 30-inch cable that is terminated with a uhf plug. The Model 6101B connects directly into the Model 610B INPUT Receptacle.

5-3. MODEL 6102A VOLTAGE DIVIDER PROBE.

a. The Model 6102A is a 10:1 voltage divider with an input resistance of 10^{10} ohms. It can be used with the Model 610B up to 1000 volts with an accuracy of 3%. The Probe is furnished with 30 inches of low-noise cable, terminated by a uhf-type plug.

b. The plug connects directly into the INPUT Receptacle. Instructions for using the Model 6102A with the Model 610B are given in paragraph 2-5.

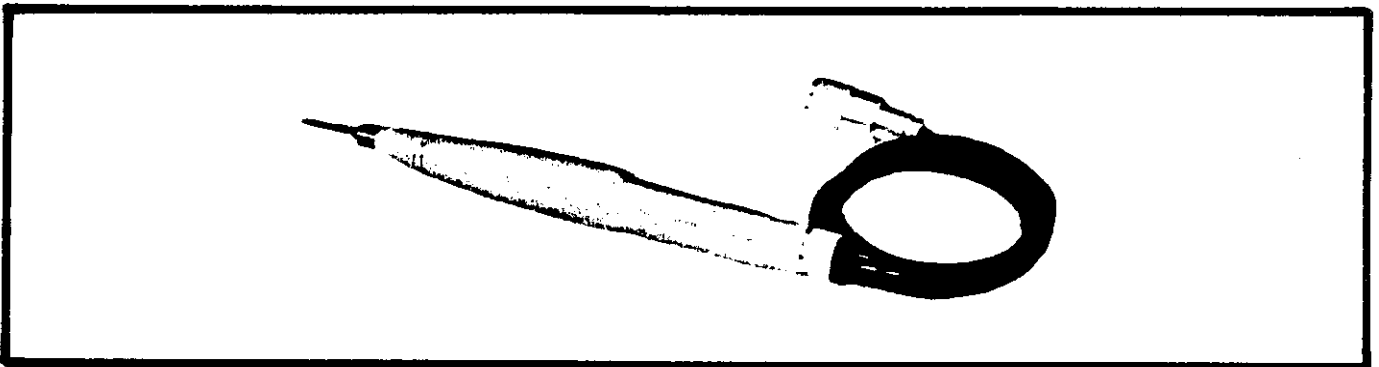

FIGURE 31. Keithley Model 6101A and 6102A. Both Models have identical external appearance

5-4. MODEL 6103A VOLTAGE DIVIDER PROBE.

a. The Model 6103A is a 1000:1 voltage divider with an input resistance of 10^{12} ohms. It can be used with the Model 610B up to 30,000 volts. Accuracy is $\pm 5\%$ to 15 kilovolts, decreasing to $\pm 10\%$ at 30 kilovolts. The Probe is furnished with 30 inches of low-noise cable, terminated by a uhf-type plug.

b. The plug connects directly into the Model 610B INPUT Receptacle. Instructions for using the Model 6103A with the Model 610B are given in paragraph 2-5.

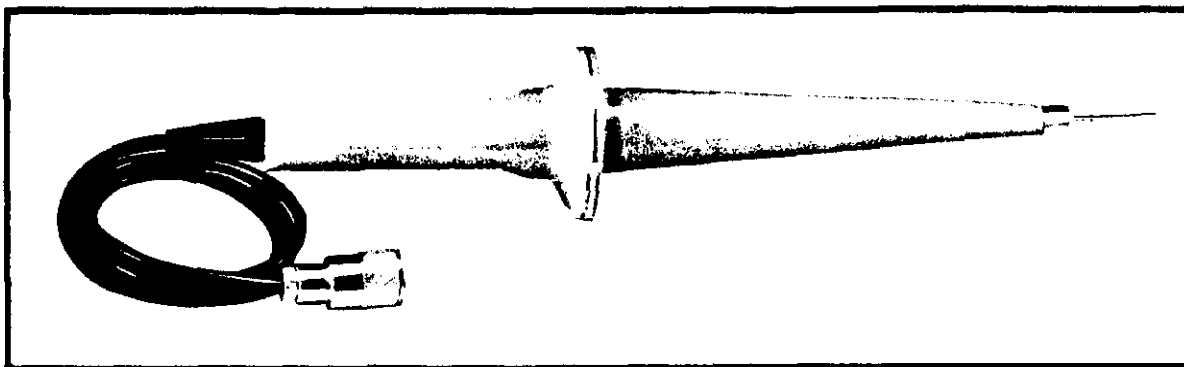

FIGURE 32. Model 6103A 1000:1 Voltage Divider Probe.

5-5. MODEL 6104 TEST SHIELD.

a. The Model 6104 is useful for making guarded measurements or to avoid pick-up problems. For resistance measurements, it can be used with either two-terminal or three-terminal connections. The Model 6104 is also suitable for voltage and current tests.

b. 2-Terminal Operation.

1. Connect the high-impedance side of the test sample to the Model 6104 INPUT terminal. Connect the low-impedance side to either black jack marked GROUND, whichever is more convenient.

2. Lock the enclosure and connect the Model 6104 bnc-type receptacle to the Model 610B INPUT Receptacle. Use a short coaxial cable lead. Operate the Electrometer as explained in Section 2.

c. 3-Terminal Operation.

1. For guarded measurements, make the connections as above with some additional steps.

2. Connect the Model 6104 black external plug to the Model 610B GUARD terminal.

3. Connect either terminal marked EXTERNAL SOURCE to the test sample at its high-impedance side. Lock the enclosure and connect the Model 6104 to the Electrometer.

4. Connect the external power source to the Model 6104 banana plugs, positive to red and negative to black. Operate the Electrometer as explained in Section 2.

5-6. MODEL 6105 RESISTIVITY ADAPTER.

a. The Model 6105 is a guarded test fixture for measuring resistivities of materials in conjunction with the Model 610B and the Model 240A Regulated High Voltage Supply. The complete system directly measures volume resistivities up to 3×10^{19} ohm-cm and surface resistivities up to 5×10^{18} ohms, in accordance with the procedures of the American Society for Testing and Materials. The shielded Model 6105 is a means for maintaining good sample contact with uniform

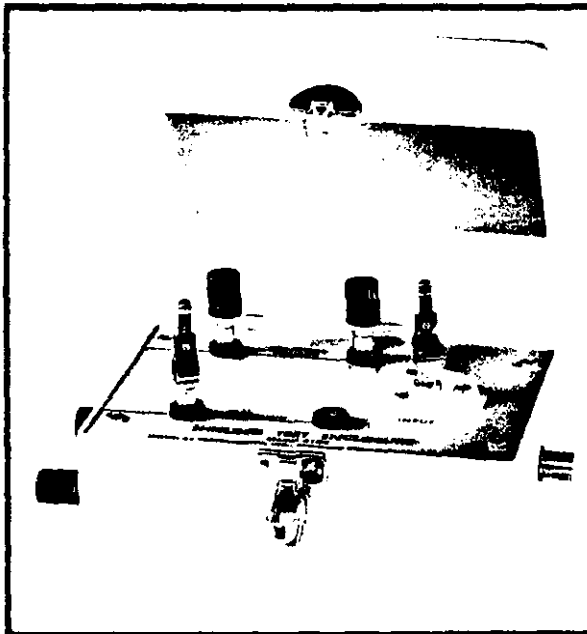

FIGURE 33. Model 6104 Test Shield.

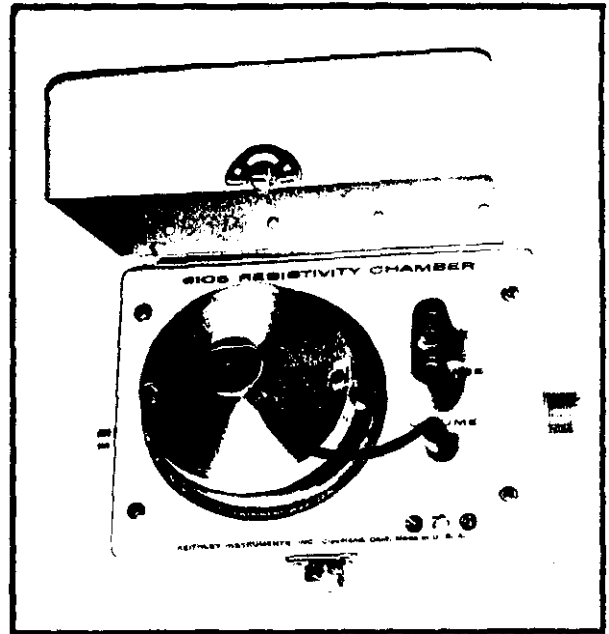

FIGURE 34. Model 6105 Resistivity Adapter.

pressure. The Adapter holds samples up to 3.5 inches in diameter and .25 inch thick. Maximum excitation voltage is 1000 volts.

b. The Model 6105 Instruction Manual fully explains the operating procedures for the system, using the Models 240A and 610B.

c. The Model 610B alone can also be used with the Model 6105. Operate the Model 610B as a constant current source (paragraph 2-11) with the FEEDBACK Switch in FAST position. Connect the GUARD Terminal on the rear panel to the center terminal of the Model 6105 Power Receptacle. Other operating procedures are as for the 3-unit system. The current from the Model 610B is the reciprocal of the OHMS setting of the Range Switch; the voltage is the Multiplier Switch setting times the meter reading.

5-7. MODELS 2501 AND 2503 STATIC DETECTOR HEADS.

a. The Model 2501 is a 10,000:1 capacitive voltage divider when used with the head 3/8 inch from the charged surface. Measurements are accurate within 10%. The Model 2501 consists of a 3-inch diameter head and 10 feet of cable. It connects directly into the Model 610B.

b. The Model 2503 is a similar probe. The difference between them is the Model 2501 has a 3-inch diameter head and the Model 2503, 1/2-inch diameter head.

c. The Models 250/2501 Instruction Manual fully explains the operating procedures for the system.

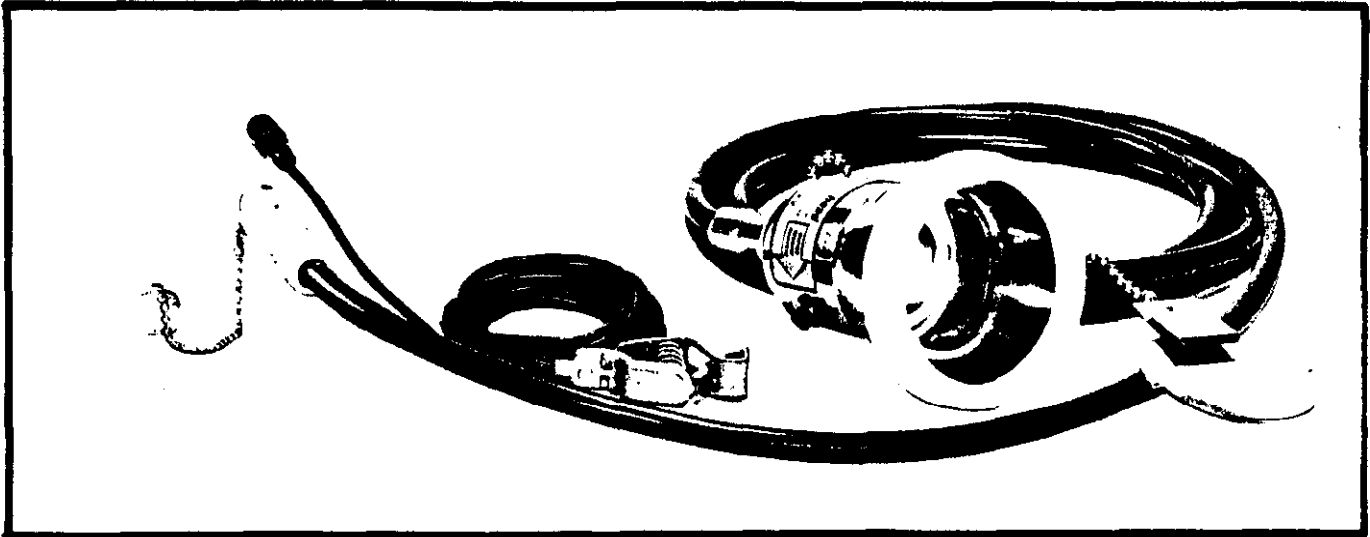

FIGURE 35. Model 2501 Static Detector Head.

5-8. MODEL 6106 ELECTROMETER CONNECTION KIT.

a. The Model 6106 Kit contains a group of the most useful leads and adapters for use in electrometer measurements with the Model 610B. The kit case is 2 inches high x 12 inches wide x 8 inches deep with polyethylene foam compartments. It weighs approximately three pounds.

b. The Kit contains two leads made with 30-inch low-noise coaxial shielded cable (RG 58A/U). One lead has a uhf plug for connection to the electrometer, and two alligator clips for connection to the circuit under test. The second lead has two uhf plugs. (See Table 2 for model numbers.) Adapters are also supplied for uhf-to-bnc conversion.

c. Other accessories include two uhf female couplers which permit cables to be connected together, a uhf "tee" connector, and a binding post adapter.

Item Fig. 36	Description	Keithley Part No.
1	Test Lead, two uhf plugs	18265C
2	Binding Post Adaptor, uhf plug	Model 6106-2
3	Two Connectors, female uhf to female uhf	CS-5
4	Two Connector Adaptors, female uhf to male bnc	CS-172
5	Connector, male uhf to female bnc	CS-115
6	Connector Adapter Tee, two male uhf and one female uhf	CS-171
7	Test Lead, uhf plugs and two alligator clips	Model 6106-1

TABLE 6. Contents of Model 6106 Electrometer Connection Kit.

5-9. MODEL 6107 pH ELECTRODE ADAPTER.

a. The Keithley Model 6107 pH Electrode Adapter is designed to allow accurate and convenient pH potential measurements with the Keithley Model 610B Electrometer and other Keithley electrometers having a uhf input receptacle. The Adapter accepts a Beckman and Coleman (B-C) or a Leeds and Northrup (L&N) connector. The two terminals on the Model 6107 marked REF accept a banana jack or a phone tip jack.

b. The Adapter uses Teflon insulation on all high impedance connections. Guarded measurements can be made with the Model 6107 by connecting the X1 OR GND Terminal on the Model 6107 to the X1 OUTPUT Terminal on the rear panel of the Model 610B. The ZERO CHECK Button on the Adapter allows checking zero on the Model 610B without shorting the pH electrodes.

c. To use the Model 6107 with the Model 610B, set both the ZERO CHECK Button on the Model 610B and the ZERO CHECK Button on the Model 6107 to the LOCK Position. The FEEDBACK Switch on the Model 610B can be in either the FAST or NORMAL Position.

d. Connect the Adapter cable directly into the Model 610B INPUT Receptacle. Connect the X1 OR GND Terminal on the Model 6107 to the Ground Post on the front panel of the Model 610B if guarded measurements are not desired. For guarded measurements connect the X1 OR GND Terminal to the X1 OUTPUT Terminal on the rear panel of the Model 610B.

e. Insert the pH electrodes into the Model 6107 and open the ZERO CHECK Button on the Model 610B.

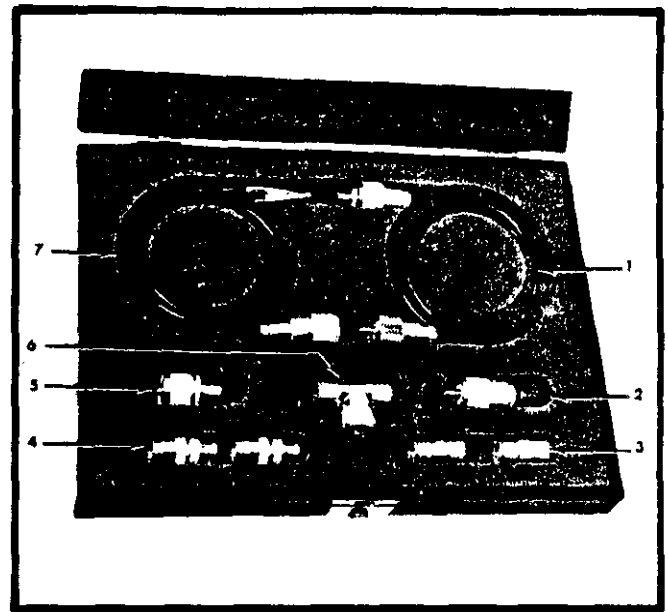

FIGURE 36. Keithley Model 6106 Electrometer Connection Kit. Refer to Table 6 for components.

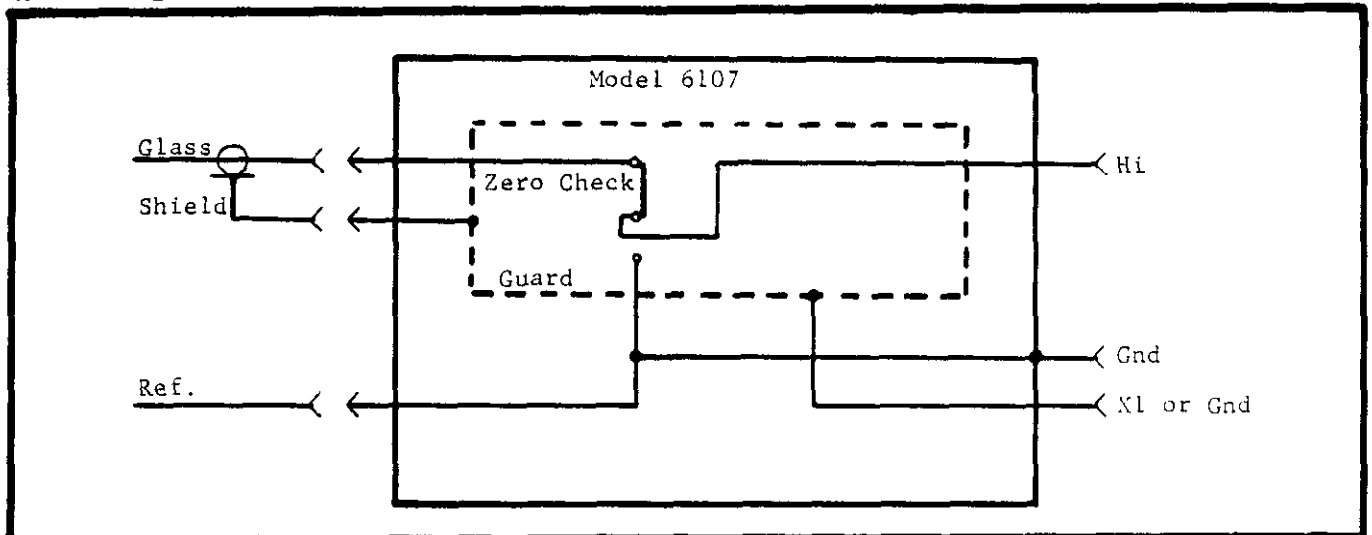

FIGURE 37. Model 6107 pH Electrode Adapter Wiring Diagram.

NOTE

To check zero on the Model 610B, use only the ZERO CHECK Button on the Model 6107. Do not use the ZERO CHECK Button on the Model 610B. The Button on the Adapter is designed to disconnect the Hi electrode before shorting the Model 610B leads. If the Model 610B ZERO CHECK Button is used to check zero the electrodes will be shorted and may be damaged.

f. To obtain a reading, set the Model 610B METER Switch to CENTER ZERO. Set the Range Switch to VOLTS. Use the appropriate range for the Multiplier Switch. Open the ZERO CHECK Button on the Model 6107. Read the voltage off the lower meter scale. To convert the voltage to pH, consult the Handbook of Chemistry and Physics.

NOTE

If the Adapter becomes contaminated, clean it with distilled water followed by a thorough swabbing with pure methyl alcohol, CH₃OH. This will suffice for most contaminants.

5-10. MODEL 370 RECORDER.

a. The Model 370 Recorder is uniquely compatible with the Model 610B as well as other Keithley electrometers, microvoltmeters and picoammeters. The Recorder is a high quality economical instrument that maximizes the performance of the Model 610B, and many other Keithley instruments, even in the most critical applications. The Model 370 can be used with the Model 610B to record voltage, resistance, currents and charge over the Model 610B's entire range.

b. The Model 610B has the output necessary to drive the Recorder directly (1 volt, 1 milliampere), thus eliminating the need for a pre-amplifier. The Model 370 floats ±500 volts off ground. The Recorder is specially shielded to avoid pickup of extraneous signals. The response time of the Model 370 Recorder is 0.5 second; linearity is ±1% of Full scale. Ten chart speeds — from 3/4 inch per hour to 12 inches per minute — are selectable with front panel controls. The 6-inch chart has a rectilinear presentation. The Model 370 Recorder has a self-priming inking system. Chart paper and ink refills are easy to install.

c. The Model 370 is very easy to use with the Model 610B. All that is necessary is connecting the two units, setting the Model 610B Output Switch to 1MA and adjusting an easily accessible control for full-scale recorder deflection. The furnished Model 3701 Input Cable mates with the output connector on the Model 610B.

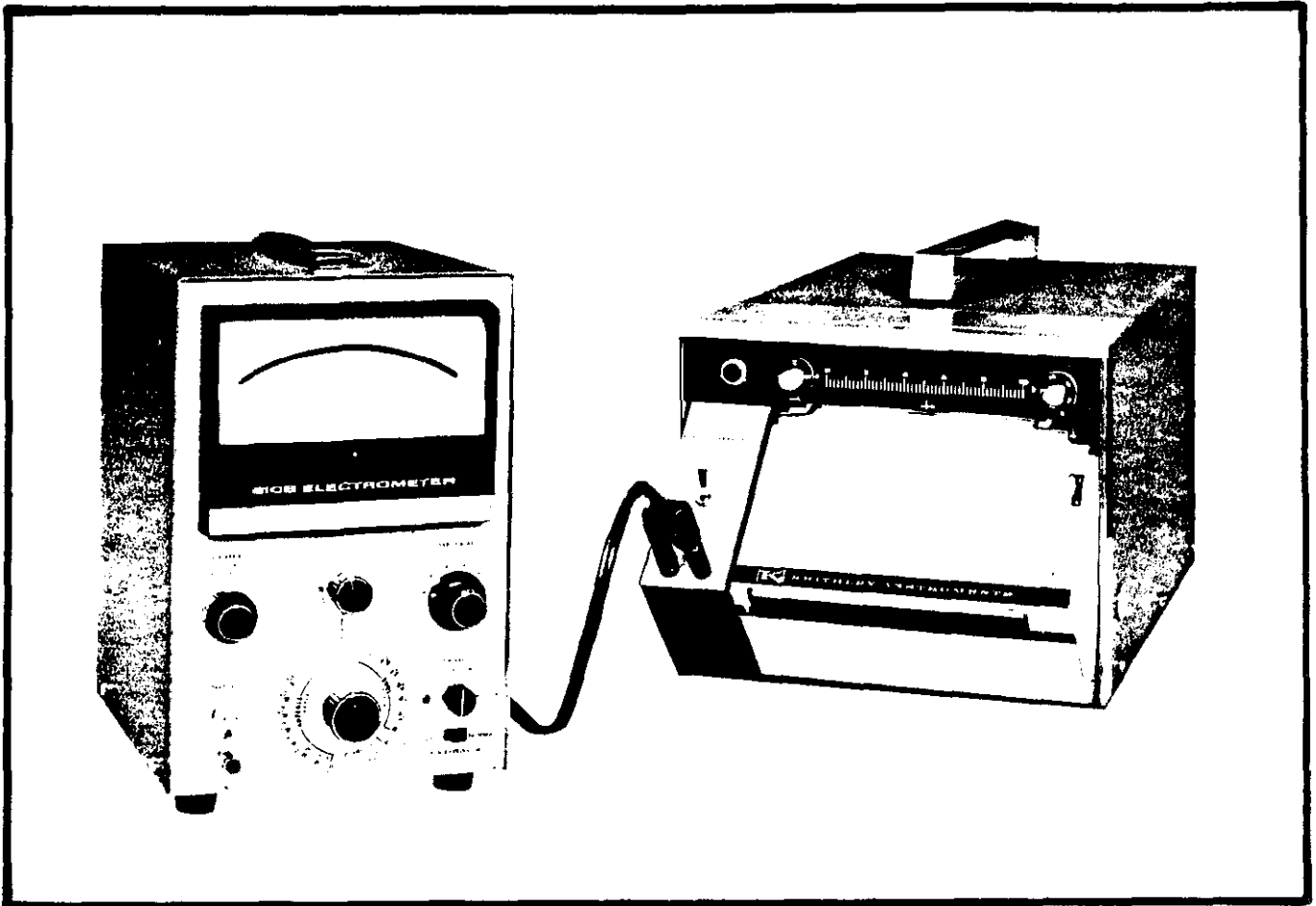

FIGURE 38. Maximum Recording Convenience is Obtained Using the Keithley Model 370, Especially Designed for use with Keithley Electrometers and Other Instruments. The Model 370 can be directly connected to the Model 610B output with the Recorder's accessory cable. Response time and other specifications of the Model 370 Recorder are compatible with those of the Model 610B Electrometer.

SECTION 6. REPLACEABLE PARTS

6-1. REPLACEABLE PARTS LIST. The Replaceable Parts List describes the components of the Models 610B and 610BR. The List gives the circuit designation, the part description, a suggested manufacturer, the manufacturer's part number and the Keithley Part Number. The last column indicates the figure picturing the part. The name and address of the manufacturers listed in the "Mfg. Code" column are contained in Table 7.

6-2. HOW TO ORDER PARTS.

a. For parts orders, include the instrument's model and serial number, the Keithley Part Number, the circuit designation and a description of the part. All structural parts and those parts coded for Keithley manufacture (80164) must be ordered from Keithley Instruments, Inc. In ordering a part not listed in the Replaceable Parts List, completely describe the part, its function and its location.

b. Order parts through your nearest Keithley distributor or the Sales Service Department, Keithley Instruments, Inc.

amp	ampere	Mfg.	Manufacturer
GerD	Ceramic, Disc	MtF	Metal Film
Comp	Composition	Mil. No.	Military Type Number
		My	Mylar
DCb	Deposited Carbon	Ω	ohm
EAl	Electrolytic, Aluminum	Poly	Polystyrene
EMC	Electrolytic, metal cased	p	pico (10^{-12})
ETB	Electrolytic, tubular	Ref.	Reference
f	farad		
Fig.	Figure	μ	micro (10^{-6})
hy	henry	v	volt
		Var	Variable
k	kilo (10^3)		
M or meg	mega (10^6 or megohms)	w	watt
m	milli (10^{-3})	WW	Wirewound
		WWVar	Wirewound Variable

TABLE 7. Abbreviations and Symbols.

MODELS 610B, 610BR REPLACEABLE PARTS LIST
(Refer to Schematic Diagram 17795E for circuit designations.)

CAPACITORS

Circuit Desig.	Value	Rating	Type	Mfg. Code	Mfg. Part No.	Keithley Part No.	Fig. Ref.
C101	22 pf	1000 v	CerD	72982	831U2M220K	C22-22P	25
C102	5 pf	200 v	Poly	14167	E1013-1	C31-5P	26
C103	.1 μ f	200 v	Poly	84171	PJ	C108-.1M	25
C104	.01 μ f	200 v	Poly	84171	PJ	C108-.01M	25
C105	.001 μ f	200 v	Poly	84171	PJ	C108-.001M	25
C106	100 pf	200 v	Poly	84171	PJ	C108-100P	25
C107	.001 μ f	500 v	Poly	71590	GPR-1000J	C138-.001M	25
C108	150 pf	500 v	Poly	71590	GPR-150J	C138-150P	25
C109	150 pf	500 v	Poly	71590	GPR-150J	C138-150P	25
C110	22 pf	1000 v	CerD	56289	5GAQ22	C72-22P	22
C111	*0.1 μ f	50 v	My	84411	601PE	C41-0.1M	21
C112	.001 μ f	1000 v	CerD	72982	801Z5V102P	C22-.001M	23
C113	.0047 μ f	1000 v	CerD	72982	811Z5V472P	C22-.0047M	23
C114**	125 μ f	15 v	ETB	73445	C426	C3-125M	19
C114***	200 μ f	3 v	ETB	56289	TE1064	C48-200M	19
C201	.001 μ f	1000 v	CerD	72982	801Z5V102P	C22-.001M	20
C202	.001 μ f	1000 v	CerD	72982	801Z5V102P	C22-.001M	20
C203	40 μ f	200 v	EMC	53021	505-1022-01	C19-40M	23
C204	500/500 μ f	35/35 v	EMC	53021	505-2603-01	C20-500/500M	23
C205	100 μ f	15 v	EAL	56289	89D217	C93-100M	23
C206	40 μ f	350 v	ETB	56289	TVA1611	C23-40M	23
C207	40 μ f	350 v	ETB	56289	TVA1611	C23-40M	23
C208	.01 μ f	1000 v	CerD	72982	811Z5V103P	C22-.01M	23
C209	500 μ f	25 v	EAL	56289	89D231	C94-500M	23

DIODES

Circuit Desig.	Type	Number	Mfg. Code	Keithley Part No.	Fig. Ref.
D201	Silicon	1N645	01295	RF-14	23
D202	Zener	1N715	12954	DZ-22	23
D203	Silicon	1N645	01295	RF-14	23
D204	Silicon	1N645	01295	RF-14	23
D205	Silicon	1N3256	02735	RF-22	23
D206	Silicon	1N3256	02735	RF-22	23
D207	Zener	1N723	12954	DZ-17	23
D208	Silicon	1N645	01295	RF-14	23
D209	Silicon	1N645	01295	RF-14	23
D210	Zener	1N936	04713	DZ-5	23

** Used with Meter ME-53A

*** Used with Meter ME-53

MISCELLANEOUS PARTS

Circuit Desig.	Description	Mfg. Code	Keithley Part No.	Fig. Ref.
DS201	Pilot Lamp, Miniature bayonet base (Mfg. No. 53)	08804	PL-20	
---	Lamp Holder (Mfg. No. 203CE)	72765	PL-18	
F201 (117v)	Fuse, slow blow, 1/4 amp, 3 AG (Mfg. No. 313.250)	75915	FU-17	5
F201 (234v)	Fuse, slow blow, 1/8 amp (Mfg. No. MDL)	71400	FU-20	5
---	Fuse Holder (Mfg. No. 342012)	75915	FH-3	
J101	Receptacle, uhf, INPUT, Mil No. SO-239A (Mfg. No. 6804)	91737	CS-64	3,4
---	Dust Cap for J101	80164	17495A	
---	(F) Plug, uhf, Mate of J101, Mil. No. 49190 (Mfg. No. 83-822)	02660	CS-49	
---	(F) Reducing adapter, uhf, for CS-64 and CS-49, Mil. No. UG-175/U (Mfg. No. 83-185)	02660	CS-36	
J102	Binding Post, Ground (Mfg. No. 33-286)	08811	BP-15	3,4
---	(F) Binding Plug (Mfg. No. 29-43)	81073	BP-10	
J103	Binding Post, X1 OUTPUT (Mfg. No. DF21RC)	58474	BP-11R	5
J104	Binding Post, GUARD (Mfg. No. DF21BLC)	58474	BP-11BLU	5
J105	Receptacle, Microphone, OUTPUT (Mfg. No. 80-PC2F)	02660	CS-32	5
---	(F) Plug, Microphone, Mate of J105 (Mfg. No. 80-MC2M)	02660	CS-33	
L201	Choke, 25 mhy (Mfg. No. 6302)	76493	CH-7	20
L202	Choke, 25 mhy (Mfg. No. 6302)	76493	CH-7	20
M101	Meter	80164	ME-53A	20
M101	Meter (Alternate)	80164	ME-53	20
P201	Cord Set, 6 feet (Mfg. No. 4638-13)	93656	CO-5	5
---	Strain Relief	80164	CC-4	
S101	Rotary Switch less components, Range	80164	SW-168	3,4
---	Rotary Switch with components, Range	80164	20339B	
---	Knob Assembly, Range Switch	80164	17033A	
S102	Slide Switch, FEEDBACK	80164	SW-45	3,4
S103	Push Button Switch, ZERO CHECK	80164	18014B	3,4
---	Knob Assembly, Zero Check	80164	14376A	
S104	Rotary Switch less components, COARSE ZERO	80164	SW-166	3,5
---	Rotary Switch with components, Coarse Zero	80164	20328B	
---	Knob Assembly, Coarse Zero Switch	80164	16373A	
---	Knob Assembly, 1 MA CAL Control	80164	16373A	
S105	Rotary Switch less components, MEDIUM ZERO	80164	SW-209	3,4
---	Rotary Switch with components, Medium Zero	80164	20360B	
---	Knob Assembly, Medium Zero Switch	80164	16993A	
---	Knob Assembly, Fine Zero Control	80164	16995A	

(F) Furnished accessory.

MISCELLANEOUS PARTS (Cont'd)

Circuit Desig.	Description	Mfg. Code	Keithley Part No.	Fig. Ref.
S106	Rotary Switch less components, Multiplier	80164	SW-167	3, 4
---	Rotary Switch with components, Multiplier	80164	20334B	
---	Knob Assembly, Multiplier Switch	80164	17032A	
S107	Rotary Switch less components, METER	80164	SW-165	3, 4
---	Rotary Switch with components, Meter	80164	17999B	
---	Knob Assembly, Meter Switch	80164	14838A	
S108	Slide Switch, Output (Mfg. No. G-326)	79727	SW-45	5
S201	Slide Switch, 117-234 v	80164	SW-151	5
T201	Power Transformer	80164	TR-70	19

RESISTORS

Circuit Desig.	Value	Rating	Type	Mfg. Code	Mfg. Part No.	Keithley Part No.	Fig. Ref.
R101	10 MΩ	10%, 1/2 w	Comp	01121	EB	R1-10M	25
R102	10 Ω	1%, 10 w	WW	91637	RSE-10	R34-10	25
R103	100 Ω	1%, 10 w	WW	91637	RSE-10	R34-100	25
R104	1 kΩ	1%, 1/2 w	DCb	79727	CFE-15	R12-1K	25
R105	10 kΩ	1%, 1/2 w	DCb	79727	CFE-15	R12-10K	25
R106	100 kΩ	1%, 1/2 w	DCb	79727	CFE-15	R12-100K	25
R107	1 MΩ	1%, 1/2 w	DCb	79727	CFE-15	R12-1M	25
R108	10 MΩ	1%, 1/2 w	DCb	79727	CFE-15	R12-10M	25
R109	100 MΩ	1%, 2 w	DCb	91637	DC-2	R14-100M	26
R110	10 ⁹ Ω	1%	Cb	63060	RX-1	R20-10 ⁹	26
R111	10 ¹⁰ Ω	1%	Cb	63060	RX-1	R20-10 ¹⁰	26
R112	10 ¹¹ Ω	1%	Cb	63060	RX-1	R20-10 ¹¹	26
R113	10 MΩ	10%, 1/2 w	Comp	01121	EB	R1-10M	22
R114	10 kΩ	1%, 1/2 w	DCb	79727	CFE-15	R12-10K	24
R115	2 kΩ	10%, 5 w	WWVar	71450	AW	RP34-2K	24
R116	9 kΩ	1%, 1/2 w MTF	DCb	07714 79727	CFE-15 L61	R12-9K	24
R117	900 Ω	1%, 1/2 w MTF	DCb	1 79727	CFE-15 L61	R12-900	24
R118	100 Ω	1%, 1/2 w MTF	DCb	07714 79727	CFE-15 L61	R12-100	24
R119	91 Ω	1%, 1/2 w	WW	01686	E-30	R58-91	22
R120	*330 Ω	10%, 1/2 w	Comp	01121	EB	R1-330	21
R121	Not Used						
R122	900 Ω	1%, 1/2 w	WW	01686	E-30	R58-900	22
R123	10 kΩ	5%, 2 w	WWVar	12697	62JA	RP42-10K	3, 4
R124	4 kΩ	1%, 1/2 w	DCb	79727	CFE-15	R12-4K	21
R125	301 kΩ	1%, 1 w	MtF	07716	CEC	R94-301K	21

* Nominal value, factory set.

RESISTORS (Cont'd)

Circuit Desig.	Value	Rating	Type	Mfg. Code	Mfg. Part No.	Keithley Part No.	Fig. Ref.
R126	3 k Ω	1%, 1/2 w	DCb	79727	CFE-15	R12-3K	27
R127	301 k Ω	1%, 1 w	MtF	07716	CEC	R94-301K	21
R128	100 Ω	1%, 1/2 w	DCb	79727	CFE-15	R12-100	19
R129	100 Ω	1%, 1/2 w	DCb	79727	CFE-15	R12-100	19
R130	100 Ω	1%, 1/2 w	DCb	79727	CFE-15	R12-100	19
R131	100 Ω	1%, 1/2 w	DCb	79727	CFE-15	R12-100	19
R132	100 Ω	1%, 1/2 w	DCb	79727	CFE-15	R12-100	19
R133	100 Ω	1%, 1/2 w	DCb	79727	CFE-15	R12-100	19
R134	100 Ω	1%, 1/2 w	DCb	79727	CFE-15	R12-100	19
R135	100 Ω	1%, 1/2 w	DCb	79727	CFE-15	R12-100	19
R136	100 Ω	1%, 1/2 w	DCb	79727	CFE-15	R12-100	19
R137	100 Ω	1%, 1/2 w	DCb	79727	CFE-15	R12-100	19
R138	^{30k} 800 Ω	1%, 1/2 w	DCb	79727	CFE-15	R12- 800 ^{30k}	27
R139	150 k Ω	1%, 1/2 w	DCb	79727	CFE-15	R12-150K	21
R140	150 k Ω	1%, 1/2 w	DCb	79727	CFE-15	R12-150K	21
R141	20 Ω	1%, 1/2 w	DCb	79727	CFE-15	R12-20	27
R142	20 Ω	1%, 1/2 w	DCb	79727	CFE-15	R12-20	27
R143	20 Ω	1%, 1/2 w	DCb	79727	CFE-15	R12-20	27
R144	20 Ω	1%, 1/2 w	DCb	79727	CFE-15	R12-20	27
R145	20 Ω	1%, 1/2 w	DCb	79727	CFE-15	R12-20	28
R146	20 Ω	1%, 1/2 w	DCb	79727	CFE-15	R12-20	28
R147	20 Ω	1%, 1/2 w	DCb	79727	CFE-15	R12-20	28
R148	20 Ω	1%, 1/2 w	DCb	79727	CFE-15	R12-20	28
R149	20 Ω	1%, 1/2 w	DCb	79727	CFE-15	R12-20	28
R150	20 Ω	1%, 1/2 w	DCb	79727	CFE-15	R12-20	28
R151	^{80k} 800 Ω	1%, 1/2 w	DCb	79727	CFE-15	R12- 800 ^{80k}	27
R152	33 k Ω	10%, 1/2 w	Comp	01121	EB	R1-33K	21
R153	33 k Ω	10%, 1/2 w	Comp	01121	EB	R1-33K	21
R154	10 Ω	10%, 1/4 w	Comp	01121	CB	R76-10	
R155	39.2 k Ω	1%, 1/2 w	DCb	79727	CFE-15	R12-39.2K	24
R156	91 k Ω	.5%, 1 w	MtF	07716	CEC	R61-91K	30
R157	27.3 k Ω	.5%, 1 w	MtF	07716	CEC	R61-27.3K	30
R158	9.1 k Ω	.5%, 1 w	MtF	07716	CEC	R61-9.1K	30
R159	2.73 k Ω	.5%, 1 w	MtF	07716	CEC	R61-2.73K	30
R160	910 Ω	.5%, 1 w	MtF	07716	CEC	R61-910	30
R161	273 Ω	.5%, 1 w	MtF	07716	CEC	R61-273	29
R162	91 Ω	.5%, 1 w	MtF	07716	CEC	R61-91	29
R163	27.3 Ω	.5%, 1 w	MtF	07716	CEC	R61-27.3	29
R164	9.1 Ω	.5%, 1/4 w	WW	01686	T-2A	R123-9.1	29
R165	2.73 Ω	.5%, 1/4 w	WW	01686	T-2A	R123-2.73	29

RESISTORS (Cont'd)

Circuit Desig.	Value	Rating	Type	Mfg. Code	Mfg. Part No.	Keithley Part No.	Fig. Ref.
R166	0.91 Ω	.5%, 1/4 w	WW	01686	T-2A	R123-.91	29
R167	20 k Ω	10%, 5 w	WWVar	71450	AW	RP34-20K	24
R168	4.99 5 k Ω	1%, 1/2 w	DCb	79727	CFE-15	R12- 5K 4.99k	21
R169	1 5 k Ω	1%, 1/2 w	DCb	79727	CFE-15	R12- 5K 1	21
R170	82 Ω	1%, 1/2 w	DCb	79727	CFE-15	R12-82	29
R171	220 Ω	10%, 1/2 w	Comp	01121	EB	R1-220	30
R172	330 Ω	10%, 1/2 w	Comp	01121	EB	R1-330	30
R173	1 k Ω	10%, 1/2 w	Comp	01121	EB	R1-1K	29
R174	20 k Ω	10%, 5 w	WWVar	71450	AW	RP34-20K	5
R175	2 k Ω	10%, 5 w	WWVar	71450	AW	RP34-2K	24
R176	4.99 500 Ω	1%, 1/2 w	DCb	79727	CFE-15	R12- 500 4.99	24
R177	2 k Ω	10%, 5 w	WWVar	71450	AW	RP34-2K	19
R178	2 k Ω	1%, 1/2 w	DCb	79727	CFE-15	R12-2K 8.46k	21
R179	8.66 k Ω	1%, 1/2 w	DCb	79727	CFE-15	R12- 8.6K	20
R180	2.73 k Ω	0.5%, 1/2 w	MtF	07716	CEC	R61-2.73K	20
R181	6.94 7 k Ω	1%, 1/2 w	DCb	79727	CFE-15	R12- 7K 6.94k	21
R182	1 7 k Ω	1%, 1/2 w	DCb	79727	CFE-15	R12- 7K 1	21
R183	Not Used						
R184	22 k Ω	10%, 1/2 w	Comp	01121	EB	R1-22K	24
R185	100 k Ω	10%, 2 w	Comp	01121	HB	R3-100K	24
R186	15 Ω	10%, 1/2 w	Comp	01121	EB	R1-15	
R201	4.7 k Ω	10%, 2 w	Comp	01121	HB	R3-4.7K	24
R202	10 Ω	10%, 1/2 w	Comp	01121	EB	R1-10	24
R203	22 Ω	10%, 1/2 w	Comp	01121	EB	R1-22	24
R204	470 k Ω	10%, 1 w	Comp	01121	GB	R2-470K	24
R205	100 k Ω	10%, 1 w	Comp	01121	GB	R2-100K	24
R206	10 k Ω	10%, 1/2 w	Comp	01121	EB	R1-10K	24
R207	10 k Ω	10%, 1/2 w	Comp	01121	EB	R1-10K	24
R208	10 Ω	10%, 1/2 w	Comp	01121	EB	R1-10	24
R209	1.2 k Ω	10%, 1/2 w	Comp	01121	EB	R1-1.2K	24
R210	1.4 k Ω	1%, 1/2 w	DCb	79727	CFE-15	R12-1.4K	24
R211	10 k Ω	10%, 1/2 w	Comp	01121	EB	R1-10K	24
R212	*1.1 k Ω	1%, 1/2 w	DCb	79727	CFE-15	R12-1.1K	24
R213	3.9 k Ω	10%, 1/2 w	Comp	01121	EB	R1-3.9K	24
R214	900 Ω 909	1%, 1/2 w	DCb	79727	CFE-15	R12- 900 909	24

*Nominal value, factory set.

TRANSISTORS

Circuit Desig.	Number	Mfg. Code	Keithley Part No.	Fig. Ref.
Q101	A1380	80164	**18548A	21
Q102	A1380	80164	**18548A	21
Q103	A1380	80164	**18548A	21
Q104	A1380	80164	**18548A	21
Q105	2N651	04713	TG-9	21
Q106	2N651	04713	TG-9	21
Q201	2N1381	01295	TG-8	23
Q202	2N1183	02735	TG-11	23
Q203	2N1381	01295	TG-8	23
Q204	2N1381	01295	TG-8	23
Q205	2N1381	01295	TG-8	23

VACUUM TUBES

Circuit Desig.	Number	Mfg. Code	Keithley Part No.	Fig. Ref.
V101	5886	80164	**EV-5886-5P	22
V102	5886	80164	**EV-5886-5P	22
V103	12AT7	73445	EV-12AT7	23

**Replace Q101, Q102 and Q103, Q104 and V101, V102 as pairs. Order only from Keithley Instruments, Inc.

00686	Film Capacitors, Inc. New York, N. Y.	04713	Motorola, Inc. Semiconductor Products Division Phoenix, Arizona
01121	Allen-Bradley Corp. Milwaukee, Wis.	07716	International Resistance Co. Burlington Div. Burlington, Iowa
01295	Texas Instruments, Inc. Semi-Conductor-Components Division Dallas, Texas	08804	Lamp Metals and Components Department G. E. Co. Cleveland, Ohio
01686	RCL Electronics, Inc. Riverside, N. J.	08811	G-C Electronics Co., Inc. Camden, N. J.
02660	Amphenol-Borg Electronics Corp. Broadview, Chicago, Illinois	12697	Clarostat Mfg. Co., Inc. Dover, N. H.
02735	RCA Semiconductor and Materials Division of Radio Corp. of America Somerville, N. J.	12954	Dickson Electronics Corp. Scottsdale, Ariz.

TABLE 8 (Sheet 1). Code List of Suggested Manufacturers. (Based on Federal Supply Code for Manufacturers, Cataloging Handbook H4-1.)

14167	Efcon, Inc. Garden City, L. I., N. Y.	75915	Littelfuse, Inc. Des Plaines, Ill.
53021	Sangamo Electric Co. Springfield, Ill.	76493	Miller, J. W. Co. Los Angeles, Calif.
56289	Sprague Electric Co. North Adams, Mass.	79727	Continental-Wirt Electronics Corp. Philadelphia, Pa.
58474	Superior Electric Co., The Bristol, Conn.	80164	Keithley Instruments, Inc. Cleveland, Ohio
63060	Victoreen Instrument Co. Cleveland, Ohio	81073	Grayhill, Inc. La Grange, Ill.
71400	Bussmann Mfg. Div. of McGraw-Edison Co. St. Louis, Mo.	83125	General Instrument Corp. Capacitor Division Darlington, S. C.
71450	CTS Corp. Elkhart, Ind.	84171	Arco Electronics, Inc. Great Neck, N. Y.
72765	Drake Mfg. Co. Chicago, Ill.	84411	Good-All Electric Mfg. Co. Ogallala, Nebr.
72982	Erie Technological Products, Inc. Erie, Pa.	91637	Dale Electronics, Inc. Columbus, Nebr.
73445	Amperex Electronic Co. Division of North American Philips Co., Inc. Hicksville, N. Y.	91737	Gremar Mfg. Co., Inc. Wakefield, Mass.
		93656	Electric Cord Co. Caldwell, N. J.

TABLE 8 (Sheet 2). Code List of Suggested Manufacturers. (Based on Federal Supply Code for Manufacturers, Cataloging Handbook H4-1.)

35

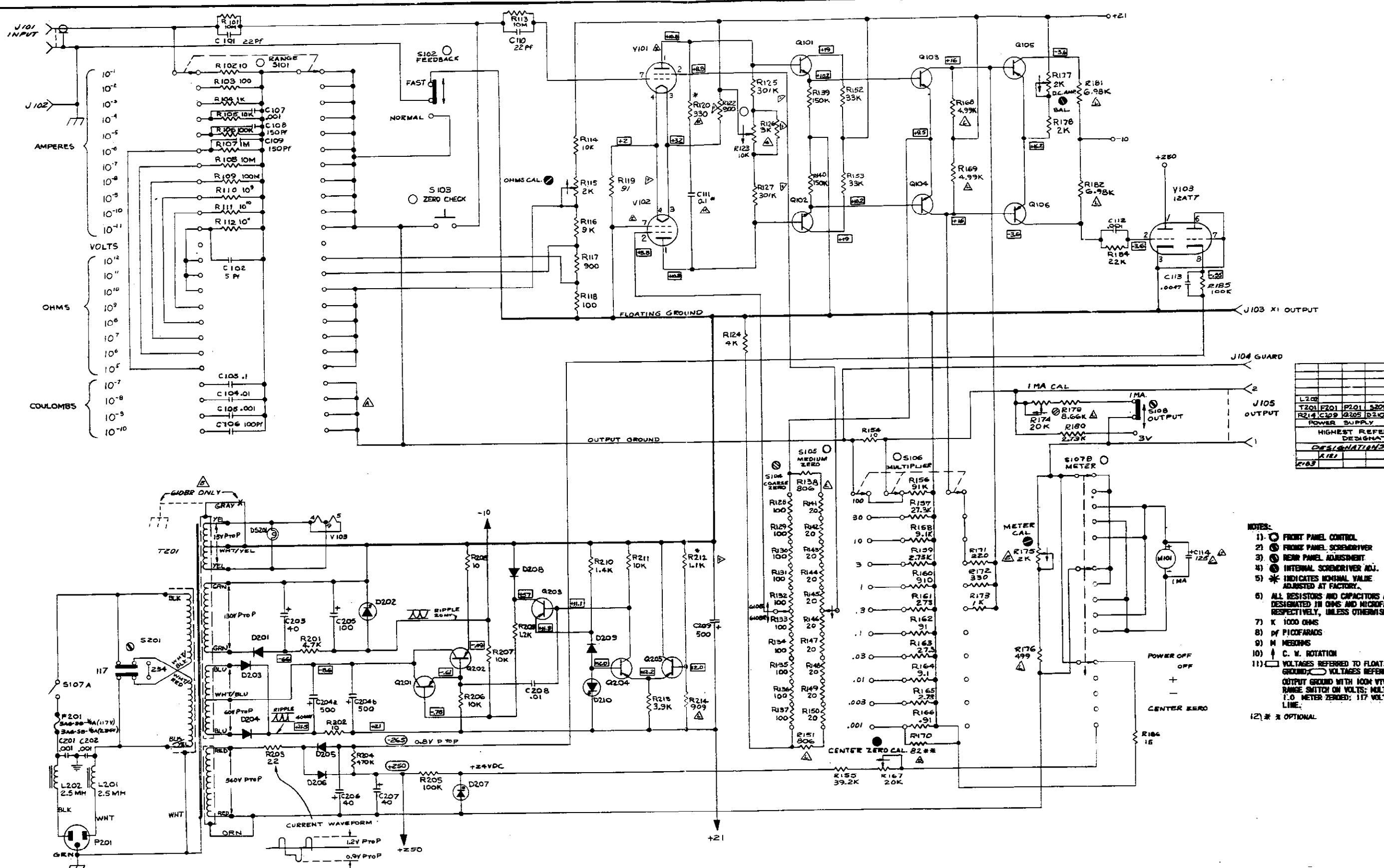

Q101	6X4
Q102	6X4
Q103	6X4
Q104	6X4
Q105	6X4
Q106	6X4
Y101	6AV6
Y102	6AV6
Y103	6AV6
V101	6X4
V102	6X4
V103	6X4

L201	
R201	
R202	
R203	
R204	
R205	
R206	
R207	
R208	
R209	
R210	
R211	
R212	
R213	
R214	
R215	
R216	
R217	
R218	
R219	
R220	
R221	
R222	
R223	
R224	
R225	
R226	
R227	
R228	
R229	
R230	
R231	
R232	
R233	
R234	
R235	
R236	
R237	
R238	
R239	
R240	
R241	
R242	
R243	
R244	
R245	
R246	
R247	
R248	
R249	
R250	
R251	
R252	
R253	
R254	
R255	
R256	
R257	
R258	
R259	
R260	
R261	
R262	
R263	
R264	
R265	
R266	
R267	
R268	
R269	
R270	
R271	
R272	
R273	
R274	
R275	
R276	
R277	
R278	
R279	
R280	
R281	
R282	
R283	
R284	
R285	
R286	
R287	
R288	
R289	
R290	
R291	
R292	
R293	
R294	
R295	
R296	
R297	
R298	
R299	
R300	

- NOTES:
- FRONT PANEL CONTROL
 - FRONT PANEL SCREWDRIIVER
 - FRONT PANEL ADJUSTMENT
 - INTERNAL SCREWDRIIVER ADJ.
 - * INDICATES NOMINAL VALUE ADJUSTED AT FACTORY.
 - ALL RESISTORS AND CAPACITORS ARE DESIGNATED IN OHMS AND MICROFARADS RESPECTIVELY, UNLESS OTHERWISE NOTED.
 - K 1000 OHMS
 - M PICOFARADS
 - M MEGOHMS
 - C. W. ROTATION
 - VOLTAGES REFERRED TO FLOATING GROUND; VOLTAGES REFERRED TO OUTPUT GROUND WITH 100M VTRM; RANGE SWITCH ON VOLTS; MULTIPLIER ON I.O. METER ZEROED; 117 VOLT - 60 cps LINE.
 - * OPTIONAL

